

**Getting Started  
With  
PartWorks**

---

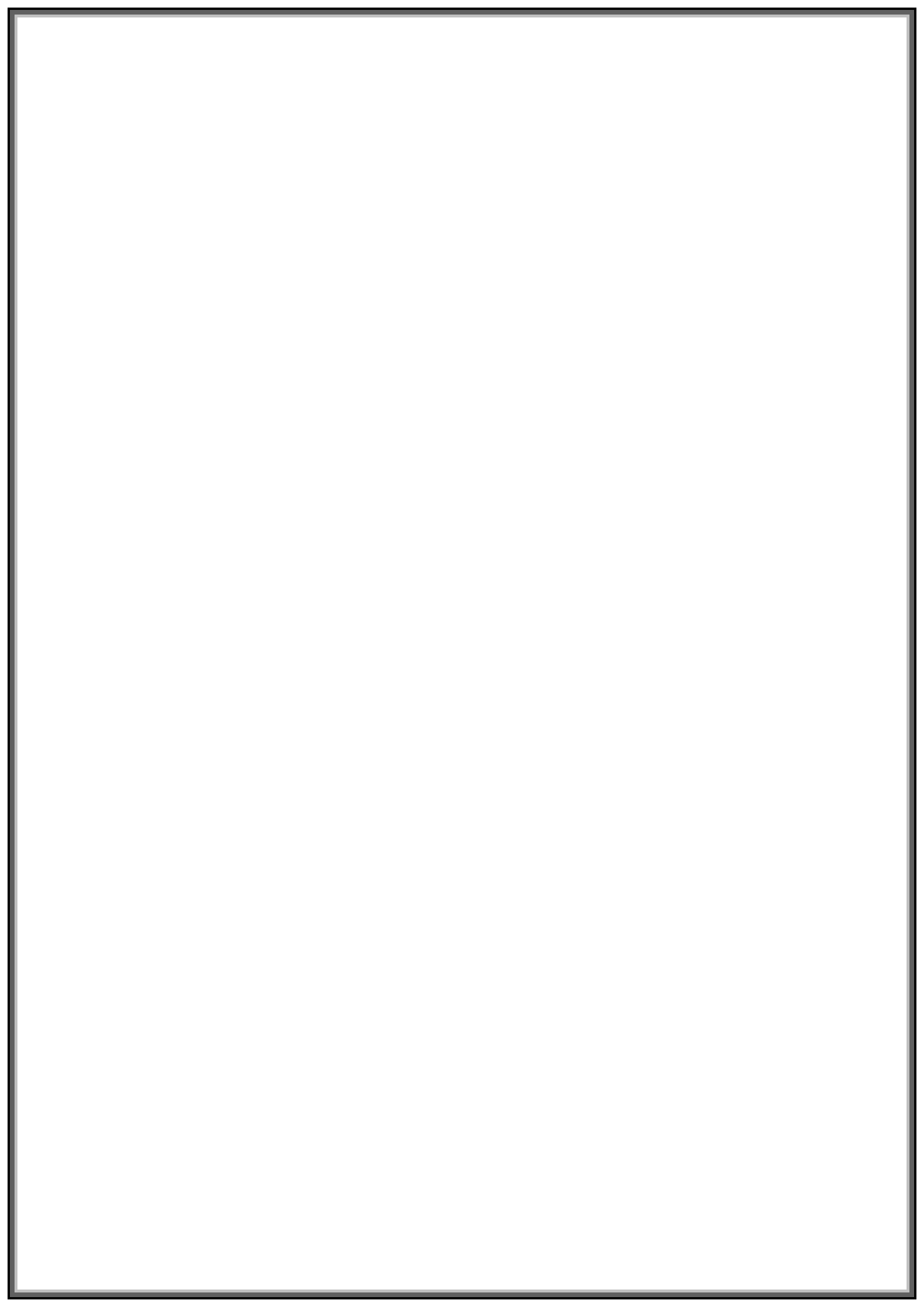

**Tutorial 2  
Flat Bottom V-Carving**



# PartWorks

---

## Disclaimer

All CNC machines (routing, engraving, and milling) are potentially dangerous and because ShopBot Tools Inc has no control over how the software described in this manual might be used. ShopBot Tools Inc or any associated Resellers cannot accept responsibility for any loss or damage to the work piece, machine or any individual, howsoever caused by misusing the software. Extreme care should always be taken and the output from the software thoroughly checked before sending it to a CNC machine.

The information in this manual may be subject to change without any prior notice. The software described in this manual is supplied under the terms and conditions of the software license agreement and may only be used in accordance with the terms of this agreement.

© Vectric Ltd  
26 Peterbrook Close  
Redditch  
B98 7YF  
UK

[www.vectric.com](http://www.vectric.com)

E-mail [info@vectric.com](mailto:info@vectric.com)  
Phone +44 (0) 1527 460 459  
Fax +44 (0) 1527 460 459

# Table of Contents

|  |    |
|--|----|
| What is V-Carving? .....                                 | 2  |
| What the software allows you to do .....                 | 3  |
| What file formats can be used? .....                     | 3  |
| Getting Help .....                                       | 3  |
| Watch the supporting tutorial videos.....                | 3  |
| <br>   |    |
| Overview of the interface .....                          | 4  |
| The VCarve Pro Logic.....                                | 5  |
| Managing windows - Auto Show / Hide.....                 | 6  |
| <br>   |    |
| View Controls.....                                       | 7  |
| 2D Design Window .....                                   | 7  |
| 3D Window .....  | 7  |
| <br>   |    |
| Vectors.....   | 8  |
| Vector selection methods.....                            | 8  |
| Vector deselect .....                                    | 8  |
| Vector editing.....                                      | 9  |
| Drawing shapes .....                                     | 9  |
| <br>   |    |
| Tutorial 2      Flat Bottom VCarving .....               | 10 |
| Introduction .....                                       | 10 |
| <br>   |    |
| 1.    Creating a New Job .....                           | 11 |
| 2.    Drawing Ovals .....                                | 12 |
| 3.    Import and modify the vector design .....          | 13 |
| 4.    Calculating the Flat Bottom V-Carve Toolpath ..... | 14 |
| 5.    Preview the Toolpaths .....                        | 17 |
| 6.    Calculating the Edge Chamfer.....                  | 18 |
| 7.    Drilling Holes .....                               | 20 |
| 8.    Calculating the Profile Cut-out Toolpath.....      | 21 |
| 9.    Preview the finished job.....                      | 24 |
| 10.   Saving the Toolpaths.....                          | 26 |

---

# Introduction

Many businesses use their CNC machine for simply cutting out flat letters and shapes from plastic sheet, or engraving standard badges and nameplates, which are all based on simple 2D machining strategies. This manual will show you how to use your CNC machine to route and engrave jobs that include decorative 3D designs that will be more interesting and hopefully more profitable if you run a business.

The manual takes you step-by-step through a number of illustrated tutorials that show and explain exactly how to use the PartWorks Software. Tips and tricks have also been included that will help you get the most from your CNC machine.

We hope you enjoy using the software.

## What is V-Carving?

V-Carving produces a constantly varying and flowing 3D carved effect on the job, which is similar to how a craftsman would carve by hand. Imagine a 'hand-carver' cutting letters into a piece of wood or stone, starting at a sharp corner, pushing the chisel deeper where the font stroke gets wider and pulling the tool out to form precise, sharp corners. V-Carving, also known as 3D Engrave or Intaglio engraving allows a V shaped or engraving tool to cut at varying Z depths that are directly linked to the width of the geometry in which the cutter is moving.

This effect is difficult to describe in words, but imagine using a flat-bottom end mill to cut 3mm (1/8<sup>th</sup>) deep inside the text shown below. The tool, being round will always leave a fillet radius in the corners and will not actually cut the complete letter where the diameter of the tool is too big to pass through the small gaps.



Sign including V-Carved Text

## What the software allows you to do

V-Carving is typically used in the following industries to add decoration to objects and products such as,

|               |  |
|---------------|--|
| Sign making   | House signs, Business, Restaurants, Pubs, Gold Leafed and Gilded |
| Woodworking   | Kitchen cabinet doors, Chairs, Doors, Table tops                 |
| Engraving     | Commemorative Brass plaques, Company logos                       |
| Gifts         | Key rings, Personalized gifts                                    |
| Stone cutting | Memorials, Commemorative engravings                              |

## What file formats can be used?

PartWorks will open files that have been saved in the following formats.

|     |  |
|-----|--|
| DXF | Drawing Exchange Files from CAD systems                            |
| EPS | Encapsulated Postscript from Adobe Illustrator and Corel Draw etc. |
| AI  | Adobe Illustrator  |
| PDF | Portable Document Format for industry standard print data          |



If the designs are being prepared with software such as Corel Draw or Adobe Illustrator we recommend that you **convert the vector geometry and text to curves** and **switch off all patterns or colour fills** before exporting as **preferably as an EPS file**.

## Getting Help

If you need assistance when using the software there are 5 primary places to look.

1. **Program Help File** - From the Main menu select Help
2. **Video Tutorials** - These are supplied on the installation CD or can be downloaded from the Vectric website.
3. **User Forum** - The Vectric user forum at [www.vectric.com/forum](http://www.vectric.com/forum) is a very useful resource for information on PartWorks along with materials, cutters etc. and also to share knowledge and experiences.
4. **E-mail Support:** - The PartWorks Support Team at [support@shopbottools.com](mailto:support@shopbottools.com)
5. **Frequently Asked Questions (FAQ)** - The support area on the Vectric web site at [www.vectric.com](http://www.vectric.com) maintains a list of the most frequently asked questions along with the answers.

## Watch the supporting tutorial videos



The video camera icon indicates there is a video file for that particular section of the manual.

Many of the tutorials and help files have associated video footage that will make learning to use this software more interesting and enjoyable. These files can be downloaded from the web site. Windows Media Player is required to view the video files.

If you experience problems running these files or need assistance please visit the technical support area on the web site and follow the links.

## Overview of the interface

The screen area is split into 6 main regions.

1. The **Main Menu bar** along the top of the screen provides access to additional, less commonly used commands available in the software. Simply click and each option will show a drop-down list of the functions.
2. The **Drawing Tab** on the left side of the screen provides general drawing tools for design modification, sizing, alignment etc. prior to machining.
3. The **Toolpath Tab** on the right side of the screen is where toolpaths are defined, calculated, edited and deleted. The Material set-up and Job Preview tools are also in this area.
4. The **Command forms** automatically appear in the Drawing window and the Toolpath tabs when tools are selected that require details to be entered such as dimensions for sizing or positioning etc.
5. The **2D Design window** is where the design is drawn, edited and selected ready for machining. Designs can be imported or created directly in PartWorks. This occupies the same area as the 3D Preview window and the display can be toggled between the two using F2 and F3 or the tabs at the top of the window.
6. The **3D Preview window** is where toolpaths and the colour shaded job preview are displayed.

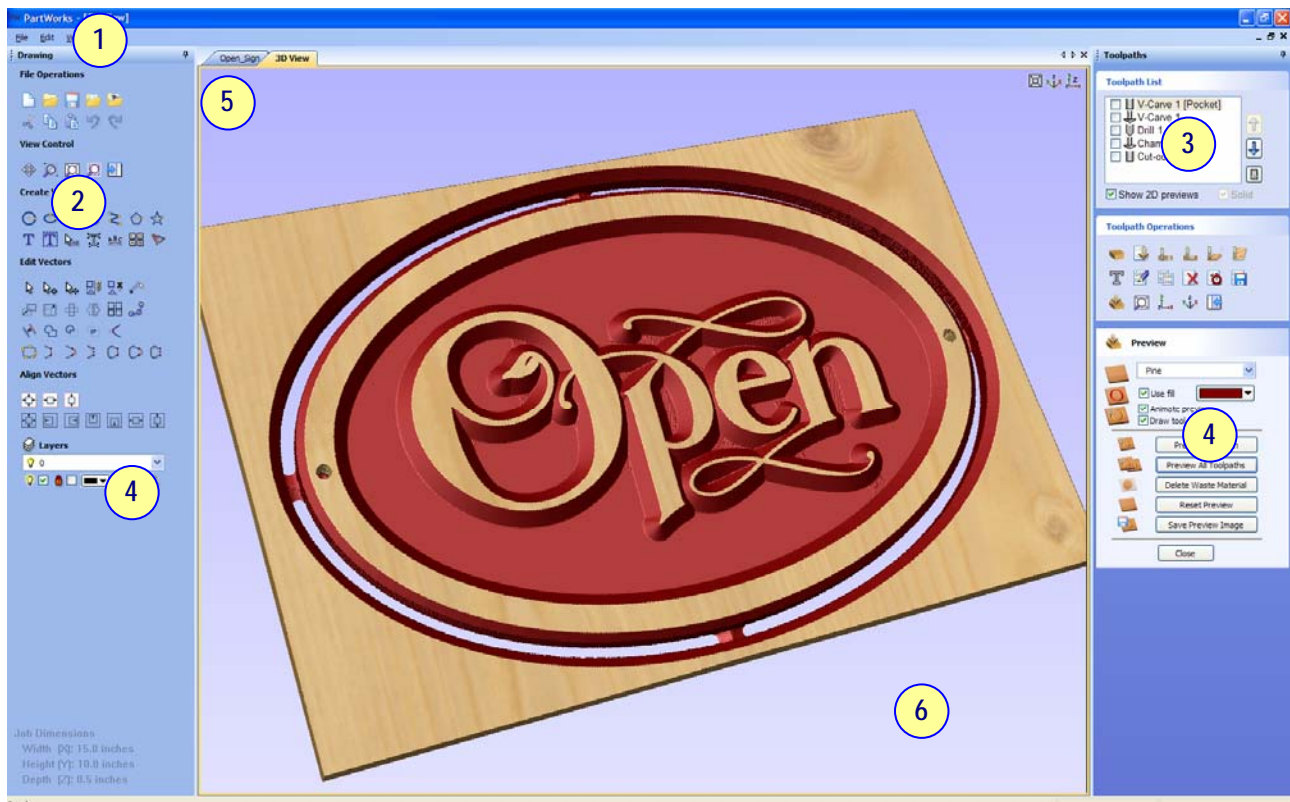

The User Interface

## The PartWorks Logic

PartWorks has been developed specifically to open decorative designs and calculate perfect 3D V-Carve / 3D Engrave toolpaths as quickly and easily as possible. The general work flow logic to apply to most jobs is explained in the diagram below.

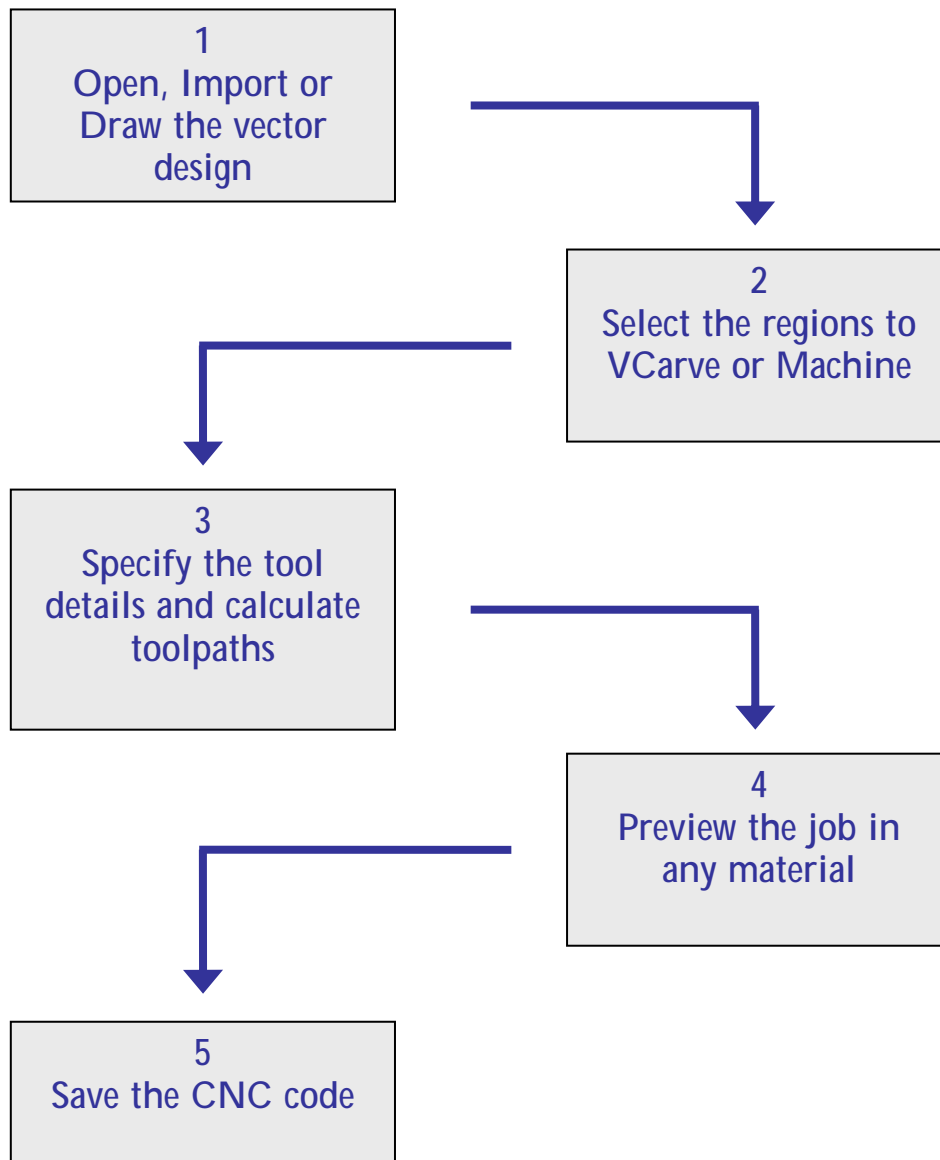

PartWorks is an excellent toolpath engine that also includes drawing and editing tools that allow designs to be created and modified. Tools for drawing, positioning, alignment and node editing are very easy to use and multiple design elements can also be drawn or imported, scaled, positioned and interactively edited to make a new design. Text can also be created using any TrueType font installed on your computer or the Single stroke engraving fonts supplied with the software.

## Managing windows - Auto Show / Hide

The two primary **Drawing** and **Toolpath Tabs** have Auto Hide / Show behaviour which allows them to automatically close when not being used, maximizing the working screen area. They can be opened and closed at any time by clicking the left mouse over the **Drawing** and **Toolpaths** tabs in the **top left** and **top right** corners of the interface.

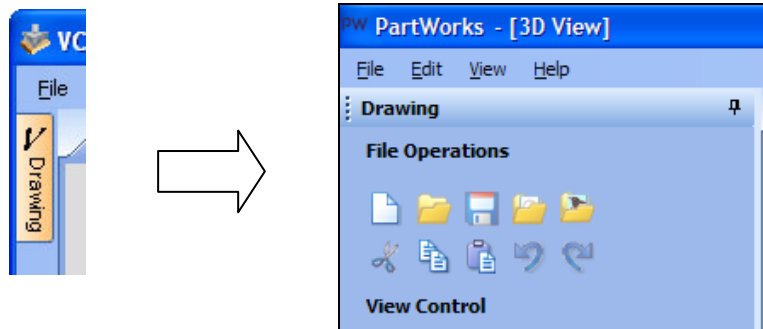

Click on the Drawing Tab to open the Drawing Window

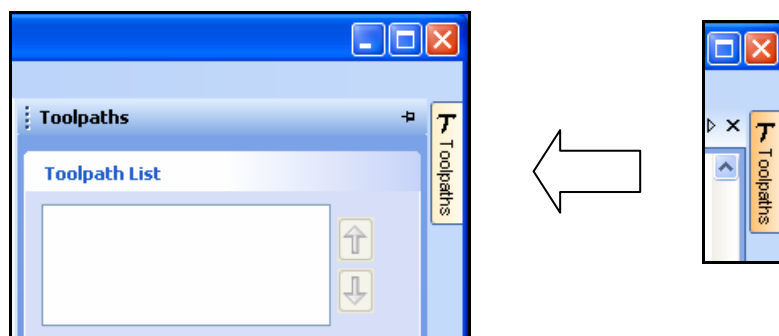

Click on the Toolpaths Tab to open the Toolpaths Window

**i** Clicking on the Drawing or Toolpath tab will also close an open window.

Both windows have Auto Hide / Show behavior and can be locked open by clicking on the **Push-Pin button** in the top right corner of the window region as shown below.

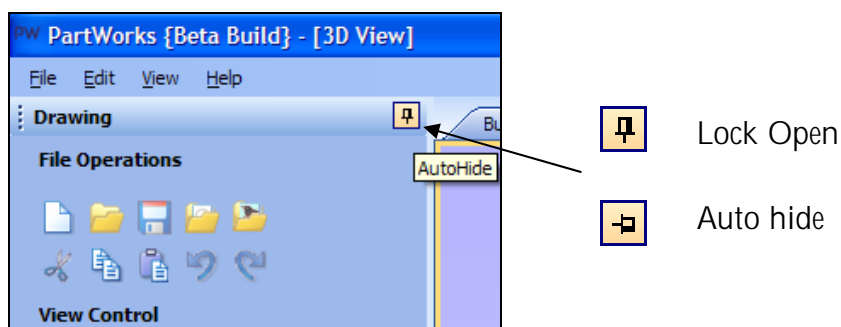







Auto Hide / Show windows

## View Controls





The View Control options available when working in the 2D Design and 3D Preview windows are,

### 2D Design Window

|   |                         |  |
|---|-------------------------|--|
|  | <b>Zoom Interactive</b> | Mouse with Middle Wheel – Push / Pull  |
|  | <b>Zoom Box</b>         | Click top left corner<br>Click bottom right corner   |
|  | <b>Pan</b>              | Click and hold the Left mouse button – Esc to cancel<br><b>Shortcut:</b> Click and drag the <b>Middle</b> mouse button |
|  | <b>Zoom Extents</b>     | Zooms to show limits of the 2D window  |
|  | <b>Zoom Selected</b>    | Click to select an object or objects<br>Zooms to the bounding box of the selections                                    |

 Mouse with Middle Wheel can be used to interactively zoom in / out.

### 3D Window

|   |                       |  |
|---|-----------------------|--|
|  | <b>3D Twiddle</b>     | Click and drag <b>Left</b> mouse button in the 3D window   |
|  | <b>Zoom</b>           | <b>Right</b> mouse button – Push / Pull<br>Mouse with Middle Wheel – Push / Pull                                   |
|  | <b>Pan</b>            | Click and drag <b>Right</b> mouse button + <b>Ctrl</b><br>Click and drag <b>Right</b> and <b>Left</b> mouse button |
|  | <b>Plan View</b>      | Looks directly down the Z axis onto the design in 3D window  |
|  | <b>Isometric View</b> | Shows the model in a 3D isometric view in the 3D window  |

 Pressing F2 & F3 will toggle between displaying the **2D & 3D windows**

## Vectors

Decorative Vector designs and shapes will usually be imported from another drawing package such as Corel Draw, AutoCAD etc. rather than being completely drawn in PartWorks. The imported Vector shape(s) can be modified, moved, scaled, rotated, mirrored or deleted.

### Vector selection methods

Multiple vectors can be selected in the following 4 ways.

1. Manual multiple selection

Hold down the **Shift** key while clicking the **Left** mouse button on each vector required.

Objects can be deselected simply clicking on the object again with the **Shift** key pressed.

2. Moving the cursor from **Left** to **Right** selects only **FULLY** enclosed objects.

Click and drag the left mouse button moving from **Left to Right** selects all objects fully inside the selection rectangle.

3. Moving the cursor from **Right to Left** selects all objects **INSIDE** the selection rectangle and also any objects that the selection rectangle **TOUCHES**.

Click and drag the left mouse button moving from **Right to Left** selects all objects inside the selection rectangle + any that the selection touches.

4. Pressing the keyboard keys **Ctrl + A** will select all vector objects in the design

 Selected vectors are displayed as dotted purple lines.

### Vector deselect

Selections can be cancelled by simply,

1. **Left clicking** on an area outside the selection.
2. Pressing the **Right mouse button** and selecting **Unselect All** (top option) from the list. You must click on the white drawing background to get this option in the menu.

## Vector editing

A design is created from vector lines, arcs and bezier spans, which all have different properties that can be selected, modified and moved at any time.



Vector Selection Tool

Selected from the Drawing tab on the left

Selected vectors are shown as dotted purple lines. Vectors need to be selected before any of the editing tools such as scaling and moving etc. can be used.



Node Editing Tool

Selected from the Drawing tab on the left

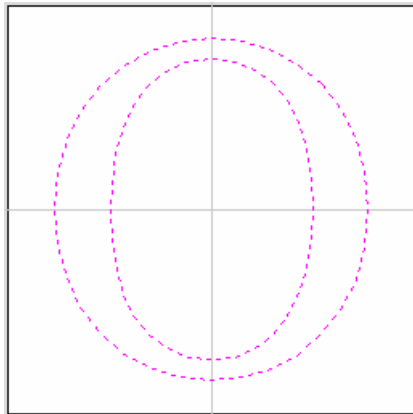

Vectors selected

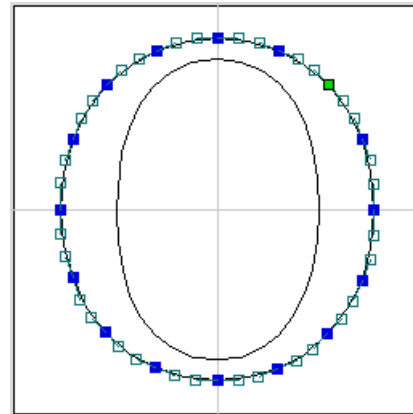

Bezier node editing

When the Node Editing tool is active the cursor changes to a Black Arrow indicating that individual points (nodes) can be edited. Nodes can be interactively moved by clicking and dragging the left mouse button on a node to select and move the node to a new position.

The shape of lines, arcs and bezier spans can be edited by clicking and dragging on the nodes or control points to move them. Multiple nodes and control points can be selected and moved by using the multiple selection options such as the Shift key and dragging to make a selection.

If you right click on nodes or spans a context sensitive popup menu will be displayed which allows you to insert or delete points and nodes, cut the vector, move the start point etc.

## Drawing shapes

Simple shapes and designs can be drawn using the Circle, Oval, Rectangle and Polyline options. These shapes are commonly used to create new borders for signs or as a reference plate for a kitchen cabinet door etc. Shapes can be created by either entering exact dimensions in the Command Window or simply clicking the left mouse button in the 2D window to specify the parameters and coordinates interactively.

Drawing shapes is covered in more detail during the tutorials in this manual.



We recommend that you watch the **7 minute Video** for this Tutorial before proceeding.

The estimated time needed to complete this tutorial is around **15 minutes**.

## Introduction

This tutorial will show you how to use the drawing and alignment tools to design, V-Carve and Drill the sign shown below Figure 1. The sign is approximately 13" (325mm) long by 8.5" (220mm) high. This design is based on decorative designs from the commercially available **Vector Art** clipart library.



Visit the Vector Art web site to purchase the reverse 'Closed' Design and make a very useful and functional sign - [www.vectorart.com](http://www.vectorart.com)

The decorative detail on the job will be carved using a 1.25" Diameter 90 Degree included angle V-bit tool and a 1/4" End Mill to cut the pocket, drill the fixing holes and profile around the sign.

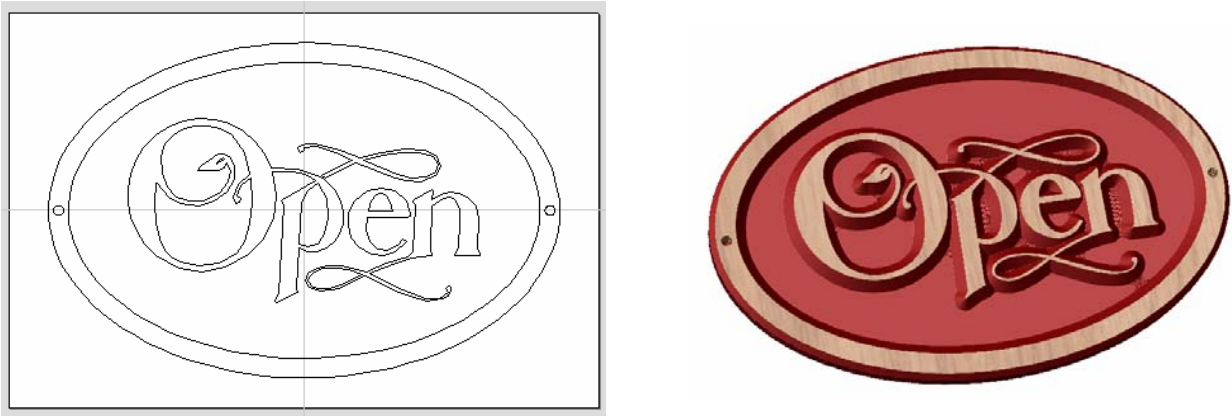

Figure 1. The finished V-Carved Open Sign

There are 9 key stages in designing and preparing toolpaths for this sign.

1. Create a new Job
2. Draw an Oval border
3. **Import** a piece of **vector clipart**
4. Scale and position the clipart ready for V-Carving
5. Calculate the **Flat Bottom 3D V-Carved toolpaths**
6. **Drill** the fixing holes
7. Calculate the **Profile** chamfer and cut out toolpaths + **Tabs**
8. **Preview** the completed **job** and **estimate** the machining **times**
9. **Save** the Toolpaths

The files required for this tutorial are installed on your PC in the folder,

**C: Program Files\ ShopBot\PartWorks\Sample Files\Open\_Sign.eps**

# 1. Creating a New Job

1. From the File menu **File Operations** toolbar click on the **New File** option and complete the form with the width, height and thickness required for this sign, as shown below.

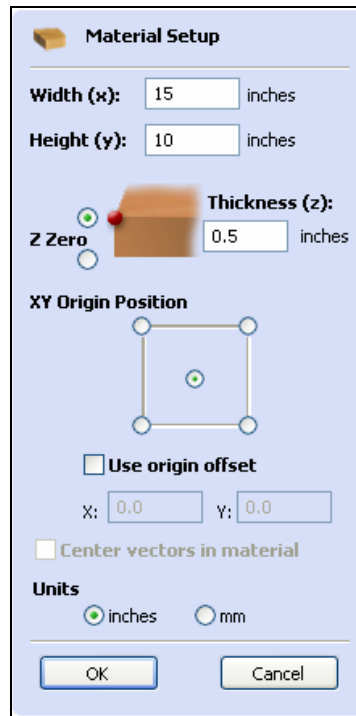

The image shows a 'Material Setup' dialog box with the following fields and options:

- Width (x):** 15 inches
- Height (y):** 10 inches
- Thickness (z):** 0.5 inches
- Z Zero:** A diagram shows a red dot on a material surface, indicating the origin.
- XY Origin Position:** A diagram shows a square with a central dot, representing the origin at the center of the job.
- Use origin offset**  
X: 0.0 Y: 0.0
- Center vectors in material**
- Units:**  inches  mm
- Buttons:** OK, Cancel

The **Z Zero origin** for setting the datum for the tool is on the **Material surface**.

The **XY Origin** will be the **Middle** of the job (easier to position when cutting an oval)

Make sure the Units are set to be in **Inches**

2. Click the **OK** button and the blank job is drawn in pale pink lines in the 2D Window.

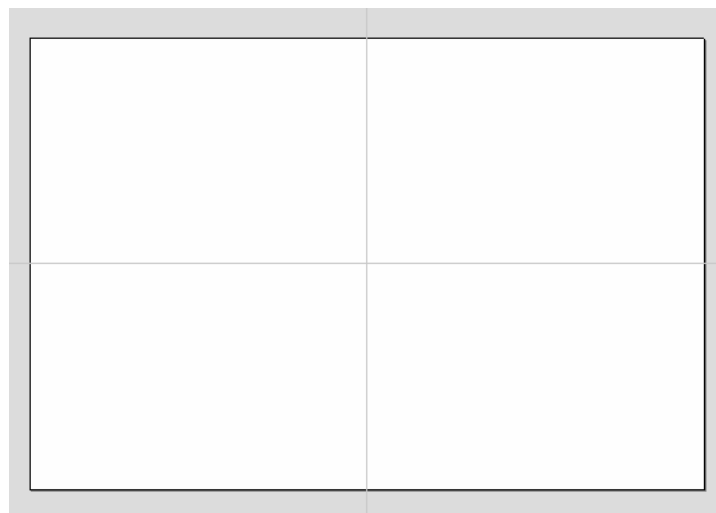

The dotted grey lines show where the X0 and Y0 axes are positioned

## 2. Drawing Ovals

With the job blank defined the next step is to draw 2 ovals for the outer edge of the sign.

3. From the Drawing Tab down the left side of the screen, select the Draw Ellipse  icon and complete the form as shown below.

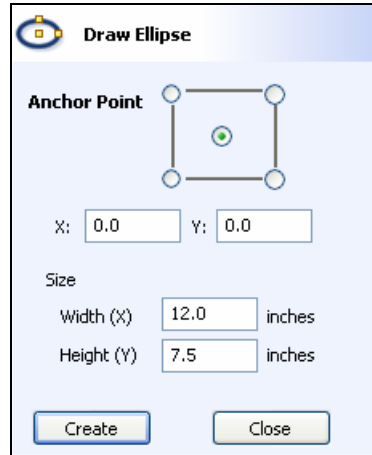

**Draw Ellipse**

**Anchor Point**

X:  Y:

**Size**

Width (X)  inches

Height (Y)  inches

Enter Width = 12" and Height = 7.5"

4. Click the **Create** button and the oval will be drawn in the 2D window
5. A second Ellipse is needed so enter Width = 13" and Height = 8.5" as shown below.
6. Click the **Create** button and the 2 ovals will be drawn as shown below.

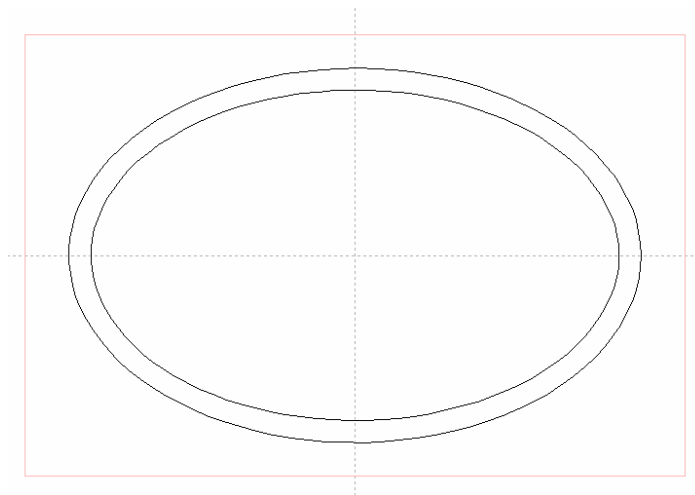

7. Click the **Close** button

**Note** The dimensions of the ovals can be changed by opening the Draw Oval form and selecting the oval to change.

### 3. Import and modify the vector design

The artwork for this design can now be imported, positioned and scaled to fit the sign.

8. From the File Operations menu select the **Import Vectors**  icon.
9. Navigate to the folder named - **C: Program Files\ ShopBot\PartWorks \Sample Files**
10. Select the file named - **Open.eps**. The design will be drawn in the 2D window as shown below.

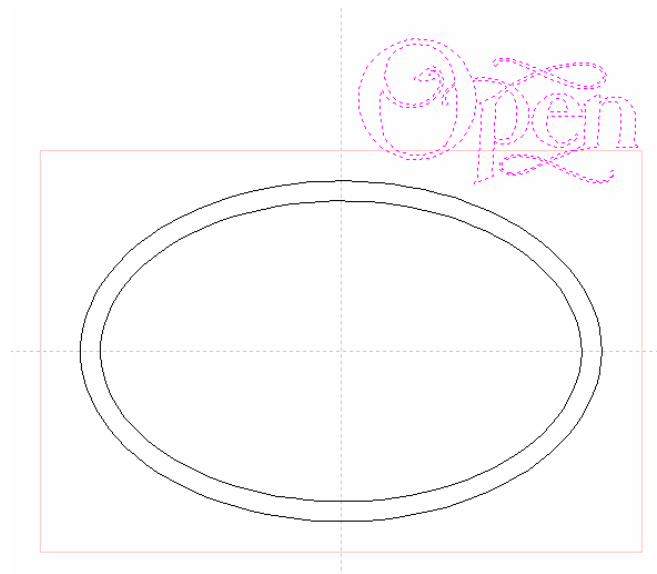

11. Click the **Center in Material**  icon (or F9) and the design moves into the middle of the job.

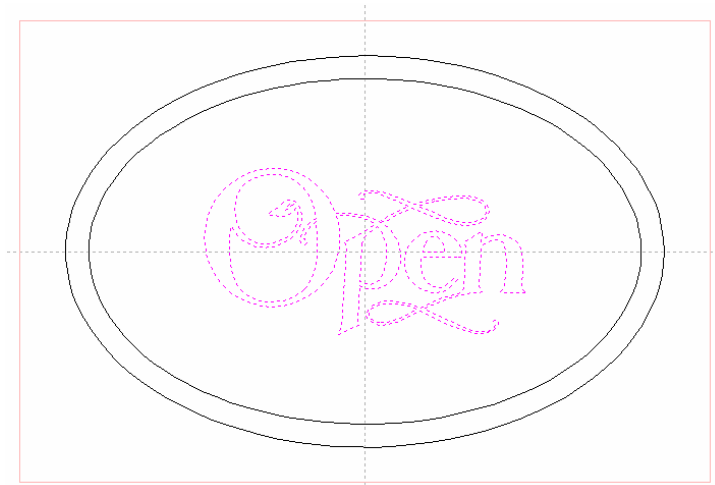

12. Click the **Scale Selected Vectors**  icon and after clicking the **Specify the exact size** check box set the width to be 9" (the height will automatically scale) as shown on the form below.

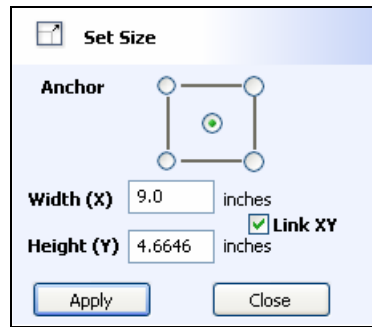

13. Click the **Apply** button and the design will be scaled exactly as shown below.

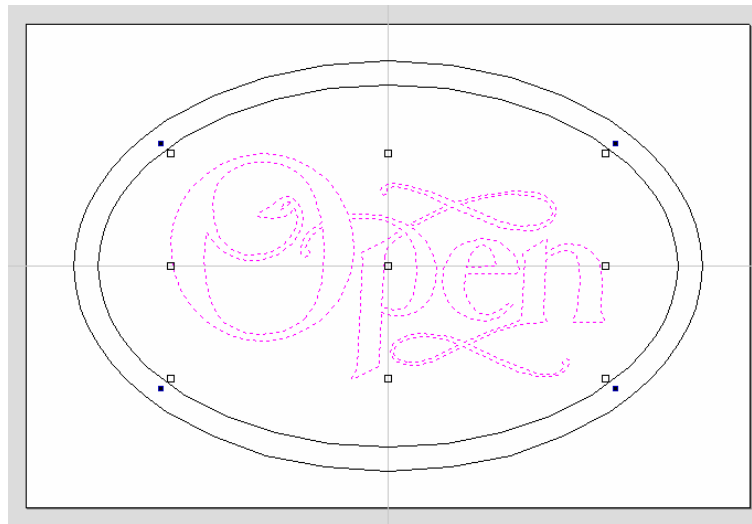

Click the **Close** button to close the form.

#### 4. Calculating the Flat Bottom V-Carve Toolpath

The design is now complete and ready to calculate the carving / engraving toolpaths.

14. Click and Drag over the complete design or Press **Ctrl + A** key to select all the vectors.
15. Deselect the outer oval by holding **Shift key** down and clicking the Left cursor on this **Oval**.
16. Alternatively, click **Left** mouse button in the **Top Left** corner then the **Left** mouse button again in the **Bottom Right** corner to enclose and select the Inner Oval + Open design.

The selected vectors are shown as dotted purple lines, as in the diagram below,

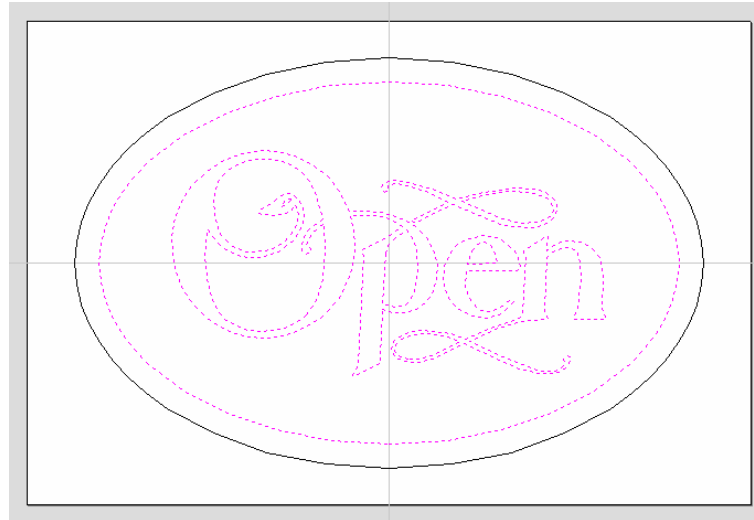

The Outer Oval should **not** be selected

17. Click the **Switch to Toolpaths Tab**  icon. This closes the Drawing Tab and opens the Toolpaths Tab on the right side of the interface (F11 and F12 are shortcuts to toggle these tabs).

18. Click on the **Setup Material**  icon and specify the **Rapid Clearance Gap** (the height above the job that the tool can move at maximum feedrate).

Enter 0.125" for the Gap and 0.750" for the Home Z height as shown below.

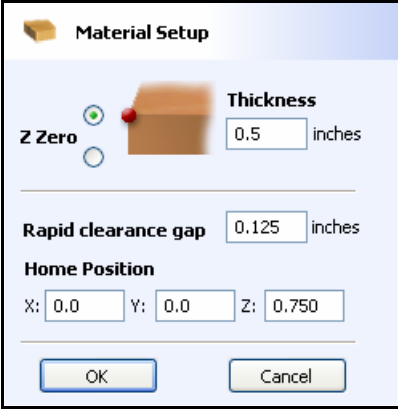

**Note** that Z Zero is set to be on the material surface.

19. Click the **OK** button.
20. Click the **Create VCarve / Engraving Toolpath**  icon and complete the form as shown below.

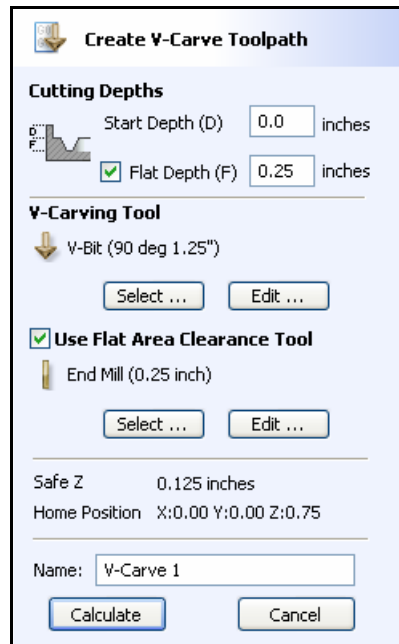

In this example the Flat Depth for the pocket will be machined 0.25" deep

Click the **Select** buttons and chose the appropriate tools from the Tool Database.

1.250" diameter 90 Degree included angle V-Bit tool to carve the detail, border and regions where the end mill did not machine. (Any diameter cutter can be used)

0.25" diameter End Mill to remove the stock from the pocket region.

The feed rates should be set to suitable values for your machine and the material being cut.

A unique name can be entered or simply left as the default.

21. Click the **Calculate** button and the Pocketing and V-Carving Toolpaths will be calculated. The 3D Window is automatically opened and the Preview form opened.

22. Click the **Plan View**  icon and the job + toolpath will be shown as below.

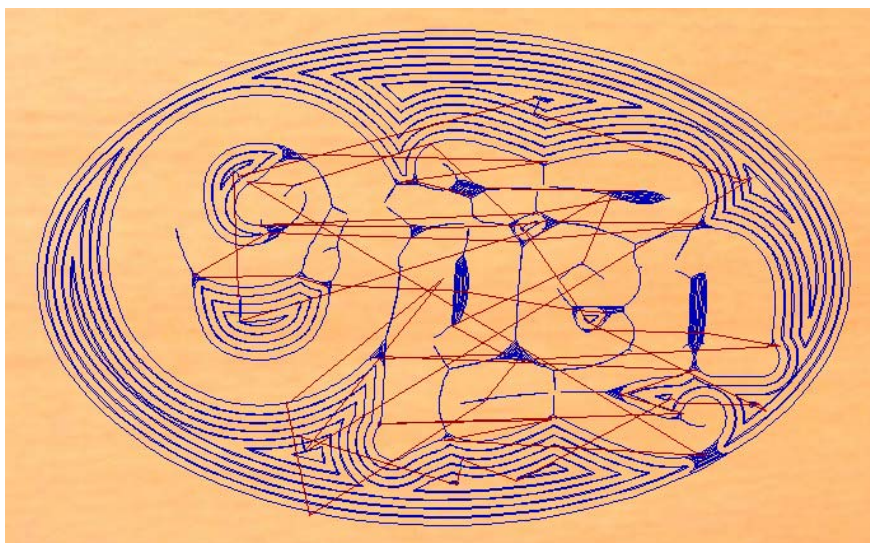

Both toolpaths displayed in the 3D Window

## 5. Preview the Toolpaths

The 2 calculated toolpaths can now be previewed to see exactly what they will produce when carved on the CNC machine.

23. Select the ISO View  icon and click Left mouse to select the first toolpath in the list,

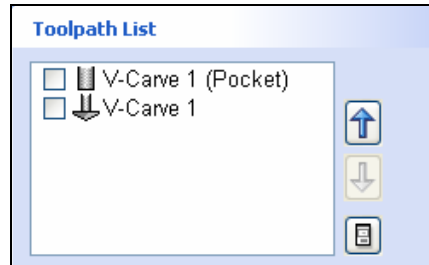

24. The **Preview form** is automatically opened.

Click on the **Preview All Toolpaths**  **Preview All Toolpaths** button and each of the tools will be shown simulating the cutting process in the 3D Window. The result is shown below,



25. From the Pull-Down lists of **Material** types and **Fill Colors**, experiment with the different options. The image in the 3D window is automatically updated with the new settings.

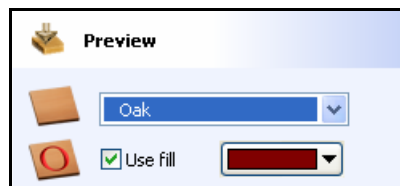



## 6. Calculating the Edge Chamfer

A 2D Machining toolpath will be used to form a chamfer around the border of the sign.

26. Open the 2D Window by clicking on the  Tab or pressing the **F2** key.
27. Press the **Esc** key or click on the background (or **Right mouse** > **Unselect all** option)
28. Select the **Outer Oval** by clicking the **Left mouse** onto the vector

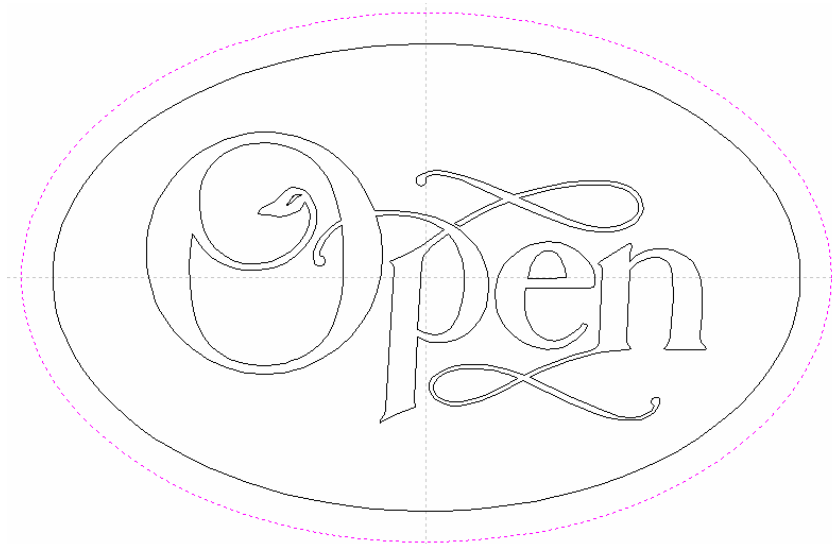

29. Click on the **Create Profile Toolpath**  icon and complete the form as shown below.

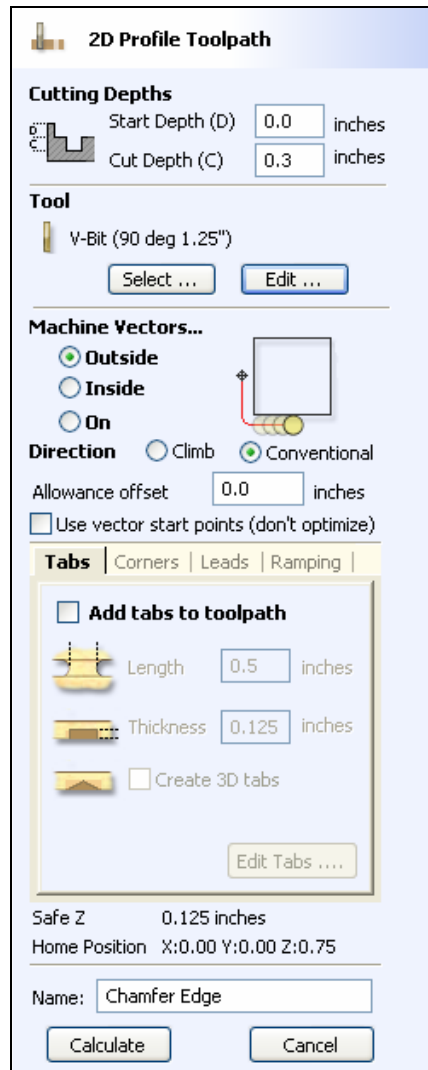

Enter a Cut Depth of 0.3"

Select Machine Vectors on the **Outside**

Click the **Select** button to open the **Tool Database** and pick the same 1.25" diameter 90 Degree included angle V-Bit tool to carve the chamfer around the edge of the sign.

The spindle speed and feedrates should be set for the specific material you are actually cutting.

Enter an appropriate **Name** for this toolpaths

30. Click the **Calculate** button. The toolpath is calculated and shown in the 3D window and the **Preview** form is opened.

Click on the **Preview Toolpath**  **Preview Toolpath** icon and the tool will be shown simulating the cutting process in the 3D Window.



## 7. Drilling Holes

The fixing holes can now be drilled on either side of the sign.

31. Click the **Switch to the Drawing Tab**  icon (or F11) to close the Toolpaths Tab and open the Drawing tools on the right side of the screen.

32. Open the **2D Window** by clicking on the  Tab or pressing the F2 key.

33. Click the **Draw Circle**  icon and complete the form as shown below,

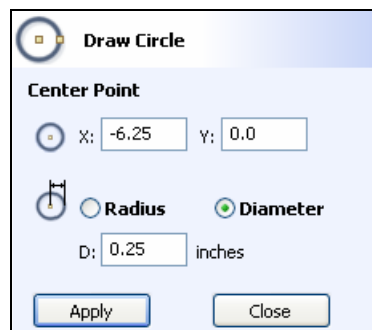

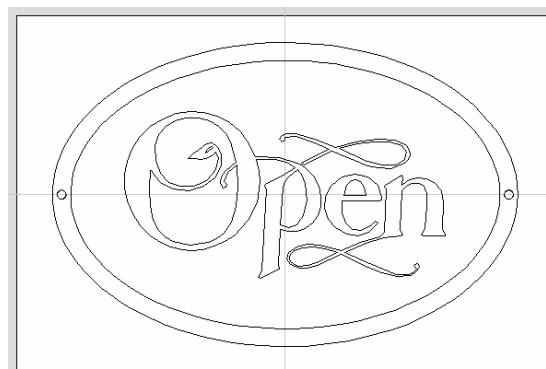

34. Click the **Apply** button to draw a 0.25" diameter circle at X -6.25" and Y 0

35. Change the coordinates for the **Center Point** to be X +6.25" and Y 0 and **Apply** to create the second circle. As shown below,



36. Select the 2 circles by holding the **Shift key** and clicking on each one.

37. Click the **Switch to the Toolpaths Tab**  icon (or **F12**) to close the Drawing Tab and open the Toolpath Tab on the right-hand side of the interface.

38. Click the **Drill Toolpath**  icon and complete the form as shown below.

Peck drilling will cut in multiple Z passes

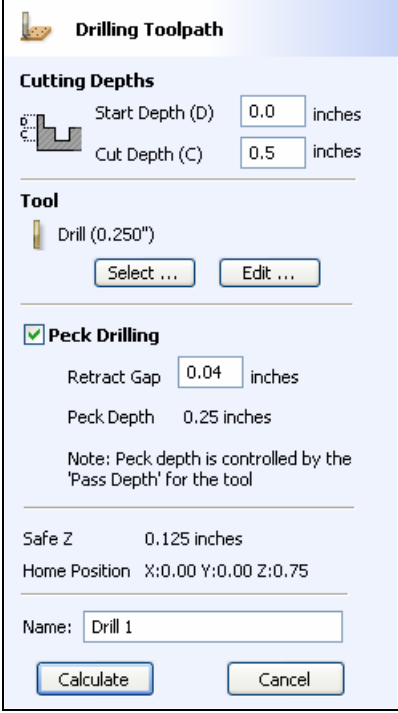

**Drilling Toolpath**

**Cutting Depths**

Start Depth (D) 0.0 inches

Cut Depth (C) 0.5 inches

**Tool**

Drill (0.250")

Select ... Edit ...

**Peck Drilling**

Retract Gap 0.04 inches

Peck Depth 0.25 inches

Note: Peck depth is controlled by the 'Pass Depth' for the tool

Safe Z 0.125 inches

Home Position X:0.00 Y:0.00 Z:0.75

Name: Drill 1

Calculate Cancel

39. Select the **0.250" Drill** from the Tool Database, switch on the **Peck Drilling** option and check the speeds and feedrates are appropriate for the material being machined.

**Notes** The **Peck Drilling cycle** will cut to the Pass Depth specified in the Tool Database for the selected drill, then retract to the Retract Gap above the material, then drill at further Pass Depths.

The depth is based on cutting to the **Point of the Drill bit**, and this may need to be increased to allow for the angle on the drill. To Drill all the way through the material may require cutting a fraction deeper to account for the angle on the Drill.

40. Click **Calculate** and the 2 drilled holes will be calculated.

## 8. Calculating the Profile Cut-out Toolpath

The oval sign can now be cut out of the rectangular block using Tab / bridges to hold the job in place.

41. Open the **2D Widow** by clicking on the  Tab or pressing the **F2** key.

42. Select the outer most oval vector by clicking with the **Left mouse button**. You should now see the new outer oval highlighted in dotted purple lines as shown below.

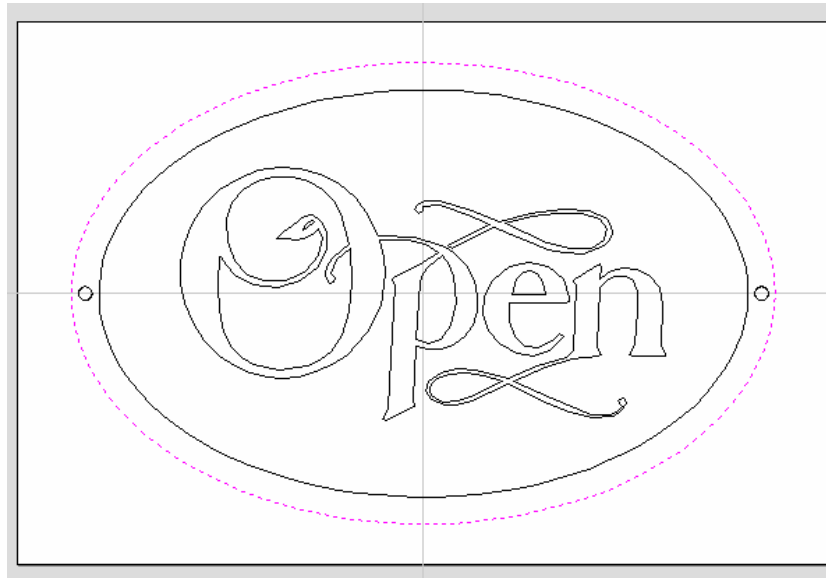

43. Click on the **Create Profile Toolpath**  icon and complete the form as shown below.

**Machine on the Outside of the oval** →  Outside

**Switch on the Tab option so the job is held in place** →  Add tabs to toolpath

**Switch on the option to create 3D Tabs** →  Create 3D tabs

**Cut Depth will cut 0.005" through the material** → Cut Depth (C) 0.505 inches

**Enter an Allowance of 0.150" to cut a larger oval** → Allowance offset 0.15 inches

**Edit the Tab positions in the 2D view** → Edit Tabs ....

Enter a Cut Depth of 0.505" – Note this will cut 0.005" through the material.

Select a 1/4" diameter End Mill from the Tool Database and specify what depth of cut per pass you wish to cut. This will depend upon the material being cut and available tooling.

The spindle speed and feedrates should be set for the specific material you are actually cutting.

44. Click the **Edit Tabs** button and complete the form as shown below.

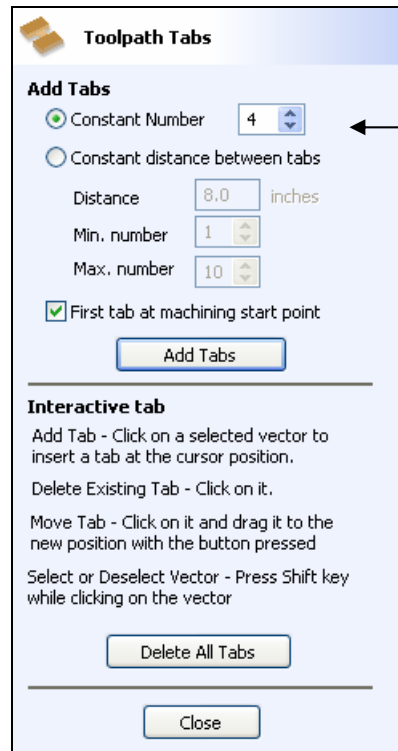

Number of  
Tabs around  
the oval

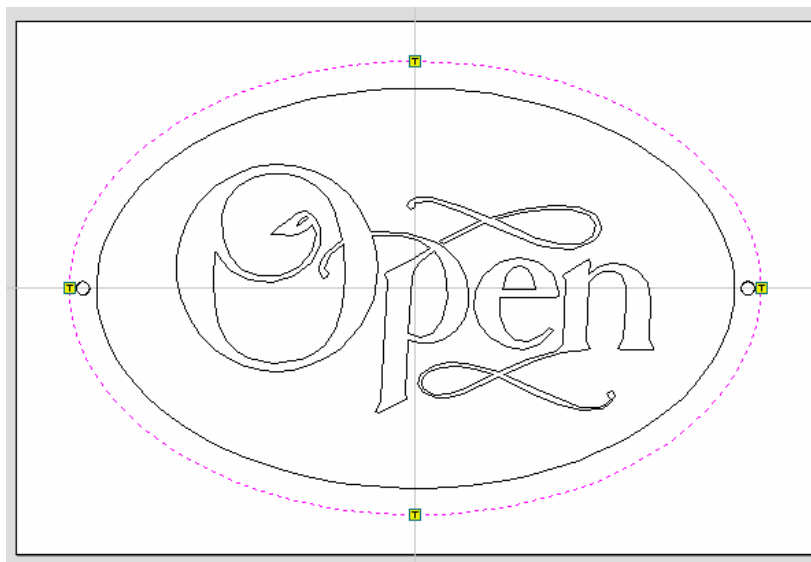

The Green boxes indicate where Tabs will be placed

**Note** The Tabs can be positioned automatically or you can simply click to add new ones or click and drag existing tabs to any position on a closed vector.

45. Select the Ramps Tab and complete the form as shown below. This will ramp the cutter into the material at a gradual angle minimizing the vertical load on the cutter and spindle.

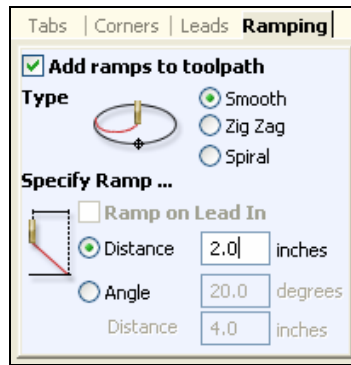

← Smooth Ramp

← Ramp in over a distance of 2"

46. Click the **Calculate** button and a message will displayed Warning you that the tool has been programmed to cut 0.00" deeper than the material thickness. **Click OK** to accept this.

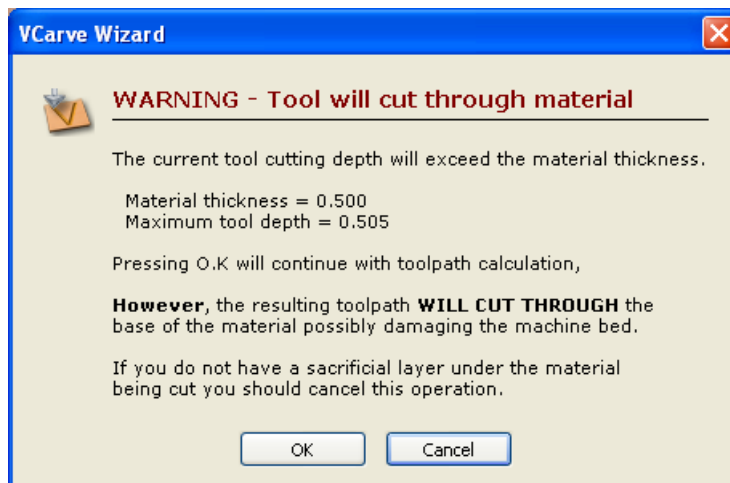

**Very Important** to You will need to have a piece of sacrificial board on the bed of your machine stop the cutter from damaging the table.

Specify a **Cut Depth = 0.500"** or less if you cannot cut all the way through the material.

47. The toolpath is calculated and shown in the 3D window and the **Preview form** is opened.

## 9. Preview the finished job

48. Click on the **Preview All Toolpaths**  **Preview All Toolpaths** button and each of the tools will be shown simulating the cutting process in the 3D Window. The result is shown below,





Zoom by Pushing / Pulling the Right mouse button

Twiddle by clicking and dragging the Left mouse button

Pan using Ctrl +Right mouse or Left + Right mouse together

48. Click the **Save Preview**   icon and save a bmp, jpg or gif image.  
Experiment with different material types and colour settings and save as different images.

Click on the Estimate Machining Times  icon to see how long the job will take to cut.

 **Estimated Machining Time**

**Total machining time**  
00:12:23

**Individual machining times**

- V-Carve 1 (Pocket) 00:06:42
- V-Carve 1 00:03:09
- Chamfer Edge 00:00:29
- Cut-out Pass 00:01:50
- Drill 1 00:00:13

---

**Time estimates based on ...**

Rapid Rate  inches/sec   
Scale Factor

This design should take around 12 minutes + tool changing time to cut

## 10. Saving the Toolpaths

49. Save the Toolpaths by clicking the Save  icon
50. Click to select each toolpath in the **Toolpath List** and **Save** each file with a new name.
51. If you have a CNC machine that has an Automatic Tool Changer (ATC), both toolpaths can be saved into a single file.

**Important** It is very important that the toolpaths for ATC machines are saved in the correct sequence. Use the Arrows on the right side of the Toolpath list to order the toolpaths.

---

Thank you for reviewing VCarve Pro and we hope you enjoyed using the software

If you have any questions or need assistance

E-mail - [support@shopbottools.com](mailto:support@shopbottools.com)

Visit the Vectric User Forum - [www.vectric.com/forum](http://www.vectric.com/forum)