

PRSalpha Air Drill (Double Valve)



Table of Contents

Overview.....	5
Spindle Mounting Plate	6
Mounting Drill Cage.....	6
Mounting Air Drill(s)	7
Connecting Air Drill(s).....	9
Connecting a Second Air Drill	10
PRSalph Wiring	11
PRS Air Drills (Double Valve)	11
Manually Testing Air Drill(s).....	12
Testing Air Drill(s) Through Software	13
Finding the XY offset between air drill(s) and spindle(s).....	13
Zeroing air drill(s) in the Z- or A-axis	13
FAQs.....	15
Creating a File Using Air Drill(s)	15
Appendix	19

Overview

The PRSalpha air drill has been designed to function and mount exclusively with ShopBot's PRSalpha line. This document will discuss the mounting and installation of the PRSalpha air drill as well as the programming necessary to use it.

The PRSalpha air drill is a pneumatic drill with a 3/8" capacity chuck that is controlled through the software. The double valve allows for the cylinder to plunge and then activate the drill only when needed, to save on air consumption. The depth and speed of plunge of the drill are determined with the z-axis, allowing for multiple hole depths within the same setup. The PRSalpha air drill is designed for point to point drilling in a variety of softer materials. While it is possible to drill into mild steel, the pneumatics were not intended for this purpose.

The PRSalpha air drill turns 2,500 RPM's with a required 90 PSI (6.2 bar) of clean, dry air. The air drill has a consumption rate of 5 cfm (36 scfm) with a torque output of 45 lbs. in. (5Nm). Decibel levels on this unit are around 84 dB. Hearing and eye protection should be worn at all times.

This unit is not recommended to be used on PRSstandard tools due to the possible loss of Z position that may occur with the open loop systems.

Spindle Mounting Plate

In most instances the spindle plate will have already been mounted to the spindle body. However, this plate may need to be updated. To see if the plate qualifies to be updated, look down the side of this spindle mounting plate. If there are **NO** 1/4-20 holes down the 1/2" edges, then an updated spindle plate is needed. Please see the appendix for how to replace the plate. If these holes exist on the 1/2" edges of the spindle mounting plate and the ShopBot is being assembled for the first time, please continue to the spindle mounting instructions. Otherwise, continue to mounting the drill cage.

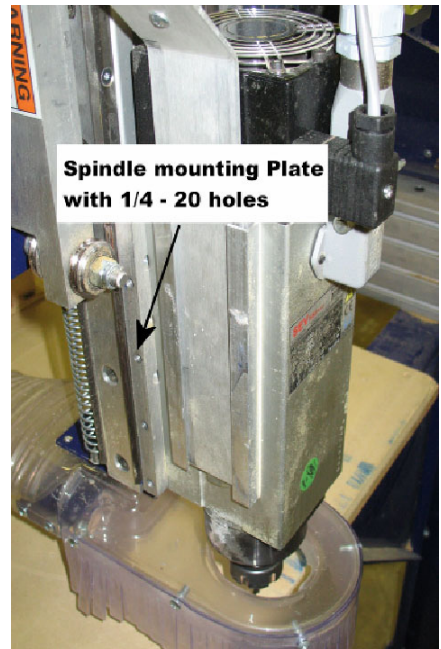
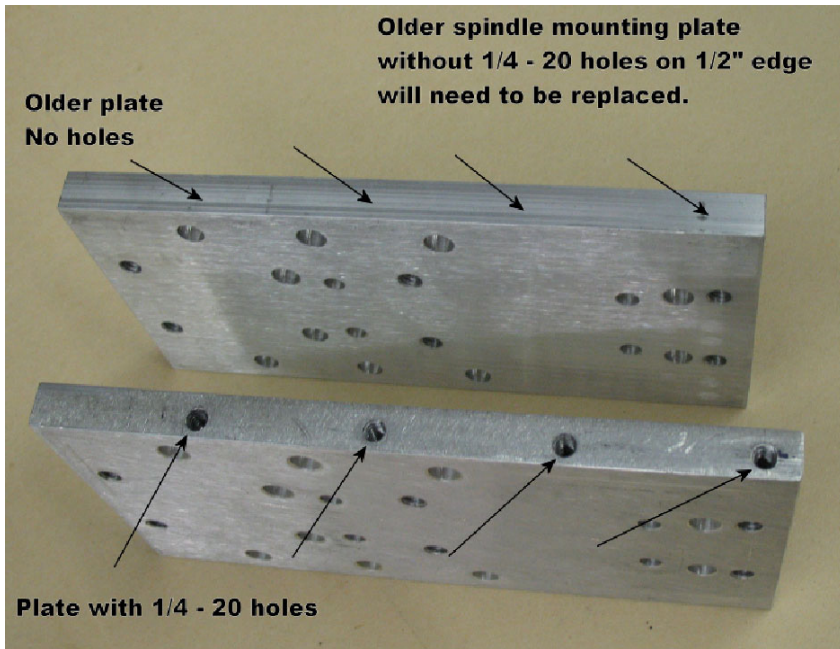

Mounting Drill Cage

Position the drill cage with the angled side facing down. Loosely mount the drill cage to the holes in the 1/2" edge of the spindle mounting plate with eight 1/4-20x3/4" button head socket cap screws. Use a square to make sure that the front face of the cage is square to the machine bed. Tighten screws firmly.

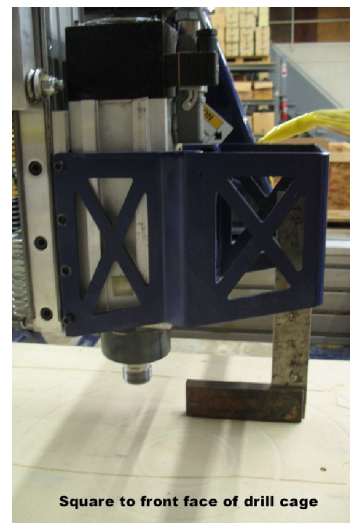
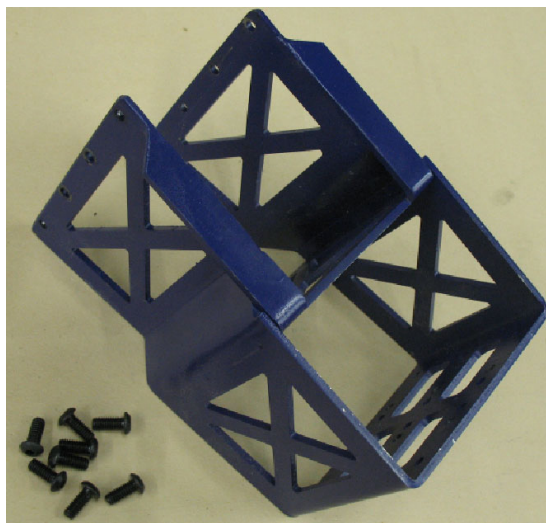

Mounting Air Drill(s)

Position the PRSalpha air drill inside the drill cage. The holes on the front face of the cage are arranged so that two air drills may be mounted inside the cage. Drills may be mounted one in the center of this area or one on either side of center. Images show from left to right: The drill as it is shipped, a single drill mounted in the center of the cage, and two drills mounted in the cage.

Consider the lengths of drill bits that will be used before mounting the air drill. The pneumatic cylinder has a 4" throw, so longer bits may cause the air drill to be mounted in the highest mounting position.

Note: Remember that the tip of the drill bit, when extended, will need to be lower than the bit in the router by a distance greater than the depth of the holes to be drilled. The goal is to allow the drill to travel its whole downward motion without the router bit hitting the part/table.

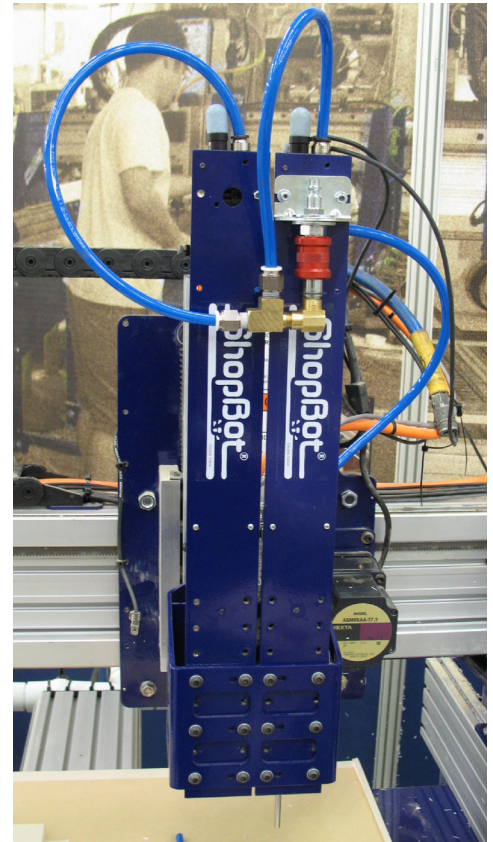
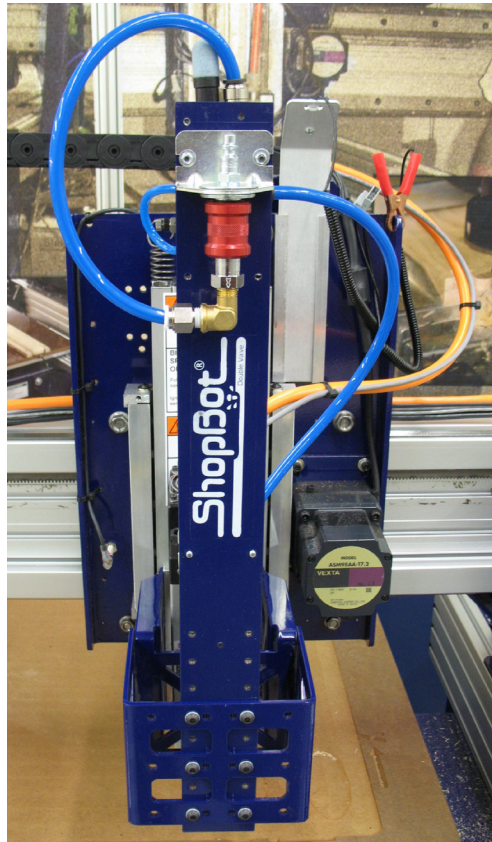
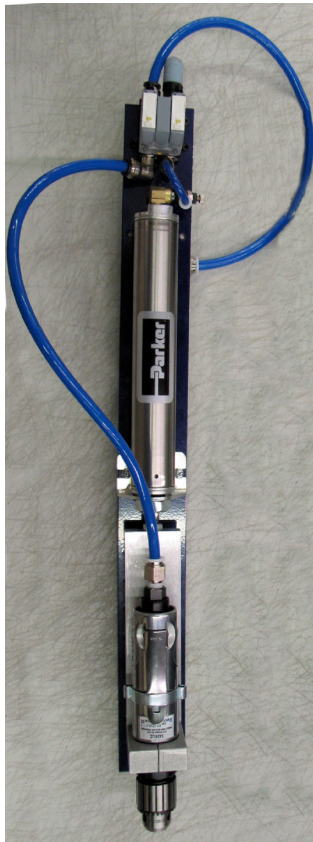

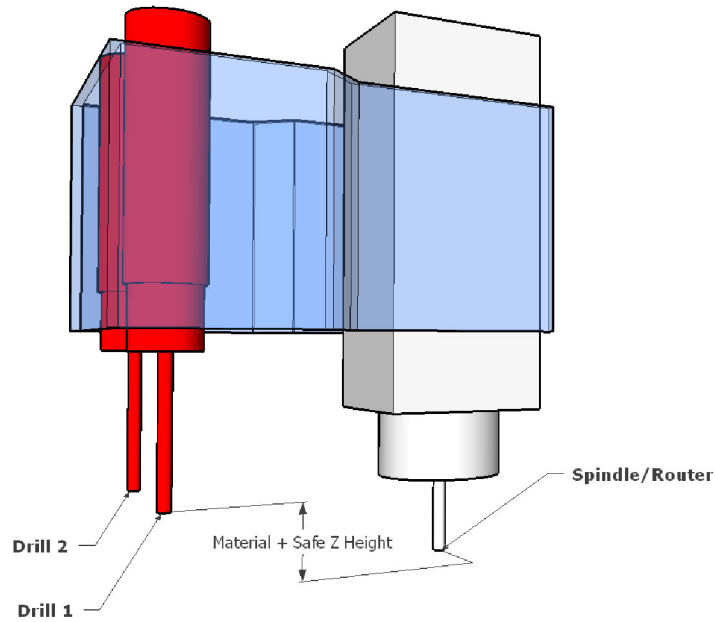

This location is a rough estimate - the actual known locations of the bits will be found in the section “Zeroing the air drill(s) in the Z- or A-axis” or by referencing www.shopbottools.com > ShopBot Docs > Accessories & Upgrades > Air Drill > “Finding offsets between two air drills”

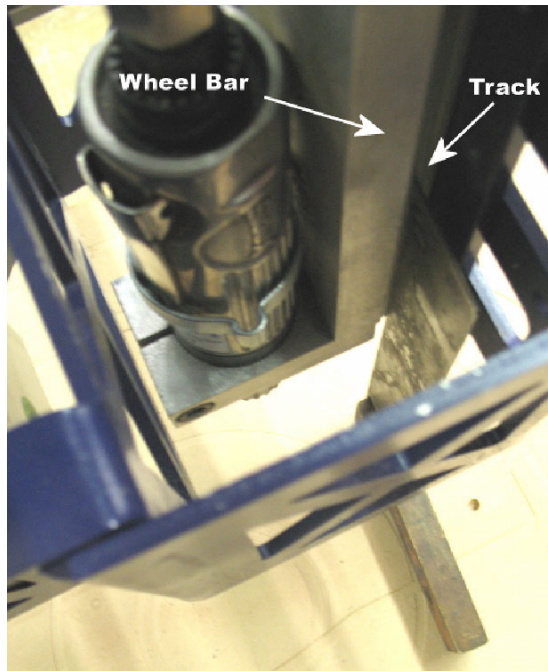

Attach the air drill plate to the drill cage by selecting the desired position. The air drill has eight holes that are spaced in 1” increments that allow for the air drill to be mounted in one of three height positions. Use the six 1/4-20 x 1/2” button head socket cap screws to mount the air drill loosely to the cage. Use a square along the extruded track to square the air drill to the machine bed as shown to the left. Tighten screws firmly.

Connecting Air Drill(s)

Locate the cables with the 90° connectors. Position the connectors so they mate to the pins on the solenoid valves, and secure them hand tight. The right solenoid valve will control the cylinder's travel (up/down), and should be connected to output 5 for a single air drill installation. The left solenoid valve controls the drill on/off, and should be connected to output 6 for a single air drill installation. Label the cables (Drill or Cylinder) to help keep track of them.

NOTE: When a second air drill is installed, connect the second air drill's right solenoid valve to output 7 and the left to output 8.

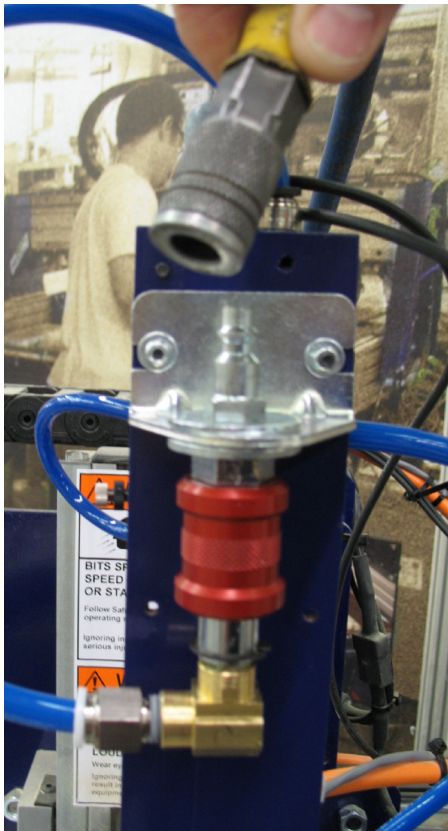
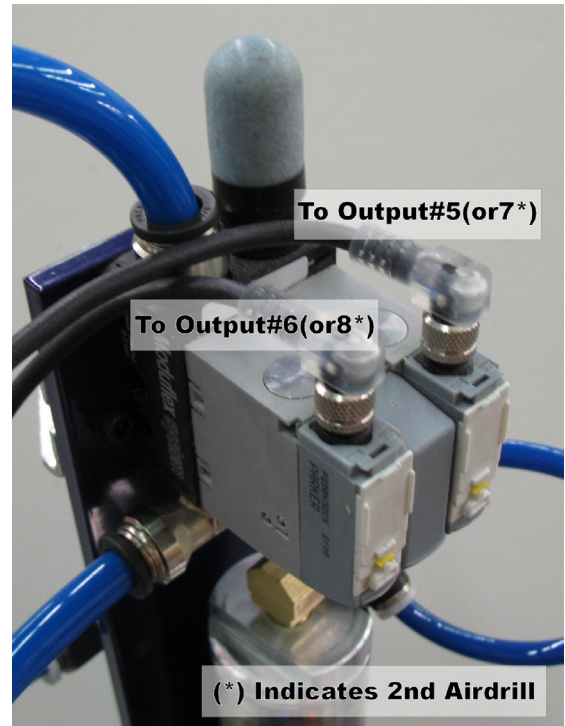

Take the female 1/4" disconnect end of the air line and connect it to the male 1/4" disconnect of the air drill. Route both the air supply line (air hose) and the cables from the 90° connectors thru the E-chain and connect the air supply into an existing air line. Route the wires from the solenoid plugs into the side of the control box.

Connecting a Second Air Drill

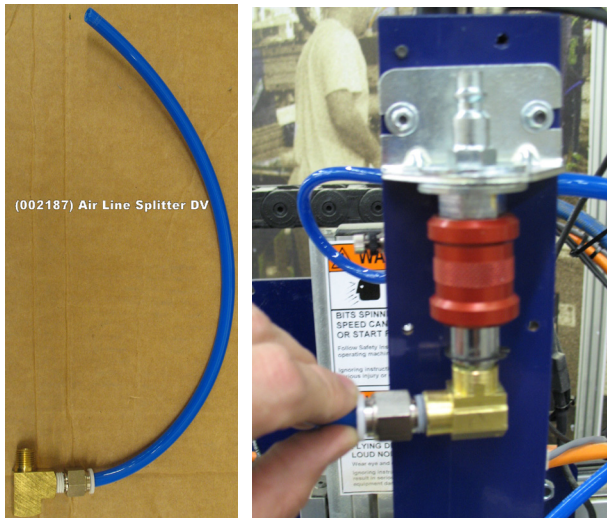

When two air drills are present, it requires the use of an air line splitter (part # 002187). Disconnect the air supply and remove the 3/8" push-in connector from the 90° elbow of air drill #1 (this part will be reused).

Thread the air line splitter horizontally into the elbow. This should come with a push-in connector already installed. Plumbers tape (not provided) is recommended on all threaded fittings to reduce leaks.

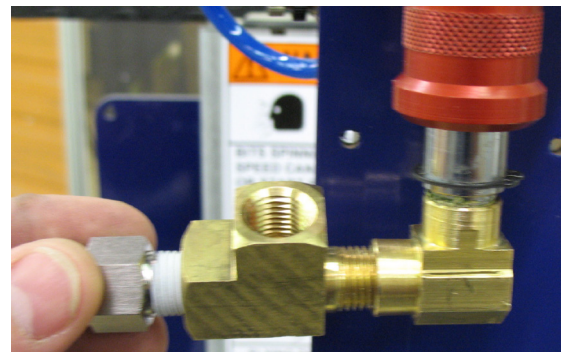

Re-install the earlier removed 3/8" push-in connector in the threaded hole in the middle of the splitter.

Re-insert the 3/8" tubing from air drill #1 and connect air drill #2 with the new section of 3/8" tubing. Remember to re-connect the air supply when done.

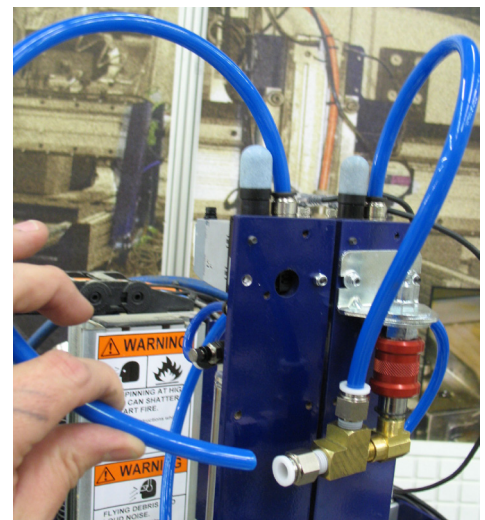

PRSalpha Wiring



NOTE: With the double valve air drill, it is currently only possible to connect two drills. Label the wires from the air drill for tracking purposes (drill #1, drill #2, etc.).

PRS Air Drills (Double Valve)

Relay board to control board connections

If the air drill was ordered at the same time as the ShopBot, the wiring of the relay board was most likely pre-installed. Verify this before proceeding. If board needs to be installed refer to “Installing a relay board for air drills and other accessories” document found on the ShopBot website under Accessories & Upgrades > Control Board Upgrades.

For the primary air drill (drill #1)

Connect a wire from position 2 (or the desired position) on the relay board to output #5 on the control board. This will signal the solenoid to activate the cylinder to plunge to depth. Place a second wire from position 3 (or the desired position) on the relay board to output #6 on the control board. This will signal the solenoid to turn the drill on/off.

For secondary air drill (drill #2)

Connect a wire from position 4 (or the desired position) on the relay board to output #7 on the control board. This will signal the second air drill’s solenoid to activate the cylinder to plunge to depth. Place a second wire from position 5 (or the desired position) on the relay board to output #8 on the control board. This will signal the second air drill’s solenoid to turn the drill on/off.

Air drill to relay board connections

Locate the black/brown and blue wires from the PRS double valve air drill labeled “Cylinder”. Connect the black/brown wire to the “NO” of relay position #2 and the blue to a ground (V- on the 24v power supply). The relay position “COM” will need to be wired to +24V (V+ on the 24v power supply), in order to power the solenoid on the air drill.

Locate the black/brown and blue wires from the PRS double valve air drill labeled “Drill”. Connect the black/brown wire to the “NO” of relay position #3 and the blue to ground (V- on the 24v power supply). The relay position “COM” will need to be wired to +24V (V+ on the 24v power supply), in order to power the solenoid on the air drill.

Check to ensure that all wires between relay board and the control board correspond to like output positions, ground, and 24v power. Reconnect power when finished.

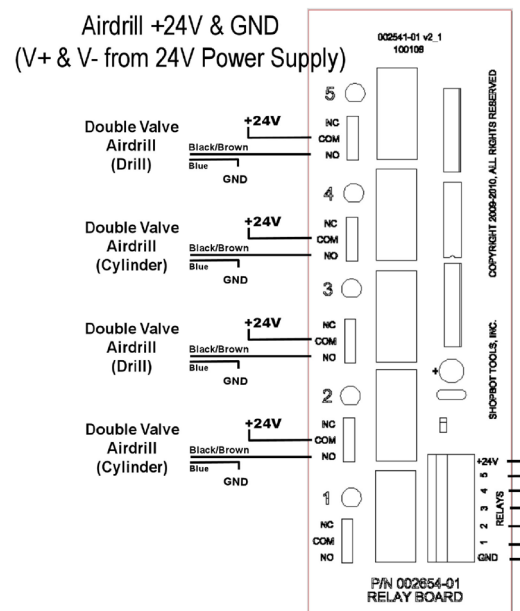

Manually Testing Air Drill(s)

WARNING: Pay close attention to the following instructions. Failure to do so may cause bodily harm.

Once the air drill(s) have been wired in and are connected to an air supply, test the unit. The air drill is equipped with a pneumatic slide valve that manually controls incoming air to the units. With the slide valve in the up position, the slide prevents any air from entering the system. Make sure that there is no drill bit in the air drill and that the chuck of the drill is greater than 4" above the machine bed. Make sure that all hands and any other items are out of the area directly beneath the air drill. Move the slide valve into the down position to allow air to flow into the system.

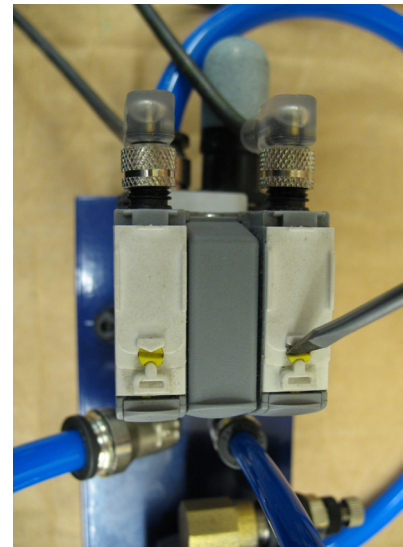

Use the small yellow switch on the solenoid to manually test the air drill. Turn the switch clockwise a 1/4 turn with a small screwdriver. As pictured above, the left solenoid will turn the drill on/off (output 6/8) and the right will trigger the cylinder on/off (output 5/7). This should activate the pneumatic cylinder or drill for the duration the switch is turned. Once the switch is released, the cylinder will return to the top of its cycle or the drill will turn off. If this performed as expected, continue. If not, check that the air supply is on and that you have 90 PSI going to the drill.

Testing Air Drill(s) through Software

Since the air drill can be switched on and off manually, the air drill(s) activation should be checked through the software. Move the slide on the air drill back to the down position (drill on). Make sure that there is no drill bit in the air drill and that the chuck of the drill is greater than 4” above the machine bed. Especially make sure that all hands and other items are out of the area directly beneath the air drill.

Power-up the control box and the SB control software. Once the SB control software is open, click on the output button for the appropriate air drill. Air drill #1 cylinder will be activated with output #5; air drill #1 drill will be activated with output #6. Air drill #2 cylinder will be activated with output #7; air drill #2 drill will be activated with output #8. With output switch #5 activated (lit up), air drill #1 should cycle on and plunge to full depth and stay there until output #5 is turned off (unlit). All other outputs should respond accordingly. If all air drills are in working order continue.

Tip: ALT + (Output #) will toggle the selected output on/off.



Finding the XY offset between air drill(s) and spindle(s)

In ShopBot control software version 3.5.4 or higher, use the “Tools” > “ShopBot setup” (TS) command to setup home position, Z zero plate thickness, and offsets between multiple spindles and air drills. For more information refer to “Finding offsets for multiple spindle / air drills” document.

Zeroing air drill(s) in the Z- or A-axis

Caution: The air drill Z height location references the location of the bit zeroed in the spindle. The spindle bit(s) must be zeroed before the bit in the air drill(s) are zeroed out.

First zero the Z- (and A-axis) spindle(s) with Zzero.sbp (C2) (or Azero.sbp) to find the location of the router bit. Open the file Drill Offset.sbp to zero the bit.

Warning: Pay attention to the following instructions. Failure to do so may cause bodily harm.

For a single valve drill make sure that the slide valve on the air drill is in the off position. Otherwise for a double valve drill you can disregard this message and click OK. The file will raise the designated Z- (or A-) axis up to 6” then activates the drill’s cylinder to plunge to full depth. Make sure that all hands and other items are out of the area directly beneath the air drill.

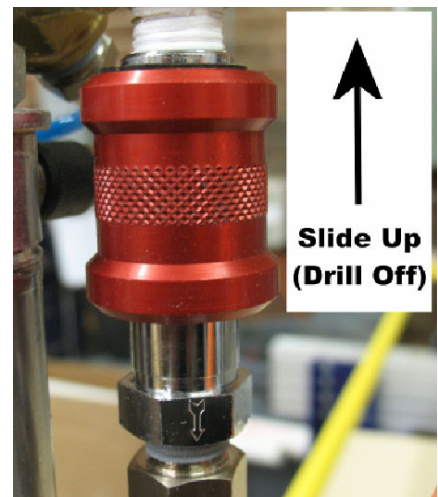
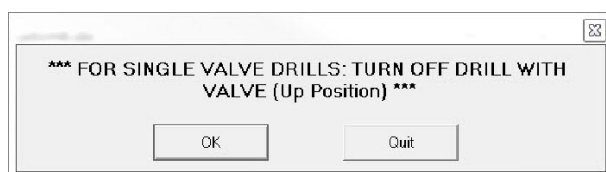

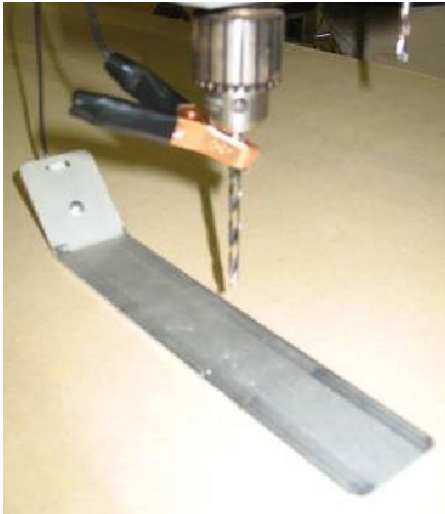

Place grounding clip on the drill bit and place the Z zero plate below the bit. Click OK.

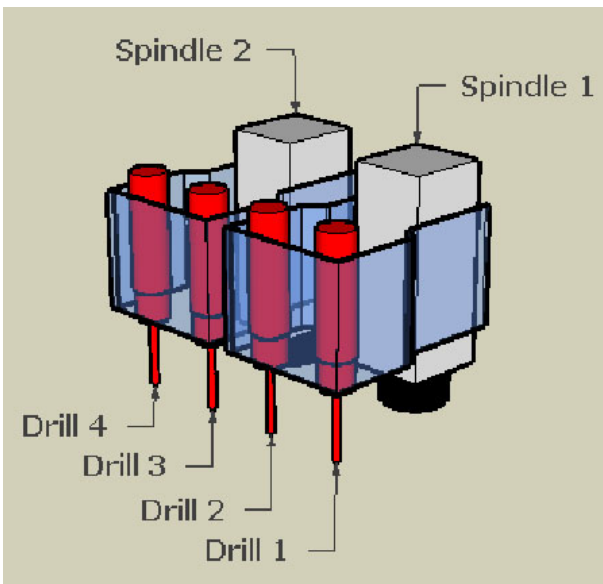
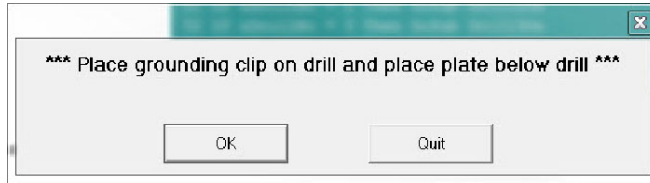

Type in drill position 1-4 for which drill location is needed to be zeroed. Click OK. The Z- (or A-) axis will move down until contact is made with the plate then move up a little, move back into the plate at a slower speed, then retract.

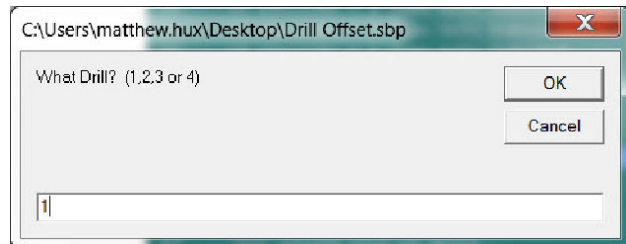

Make sure that the slide valve on the air drill is in the ON position before resuming cutting. Click OK.

Repeat the above steps for additional drill zeroing.

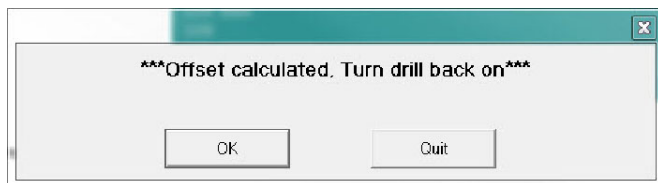

FAQs

Q: When should I re-zero the drills?

A: If a drill bit breaks, slips, or is replaced.

Q: Is it necessary to re-zero the drills if the router bit breaks?

A: Yes! Replace the router bit and zero this bit using the Z zero (or A zero) routine. Z (A) height offsets will need to be reassigned with the Drill Offset.sbp file.

Creating a File Using Air Drill(s)

The following instructions have screen shots taken from VCarve Pro. The setup is essentially the same in any software that outputs the PRS air drill post. A tool must be selected from the tool database that can be recognized by air drill software. This tool will be used to generate toolpaths in the same way the software would normally process a drilling operation, however, the tool number will dictate which air drill will do the drilling.

Draw or layout what needs to be machined in VCarve Pro or your preferred software. This example shows making holes for shelf pins.

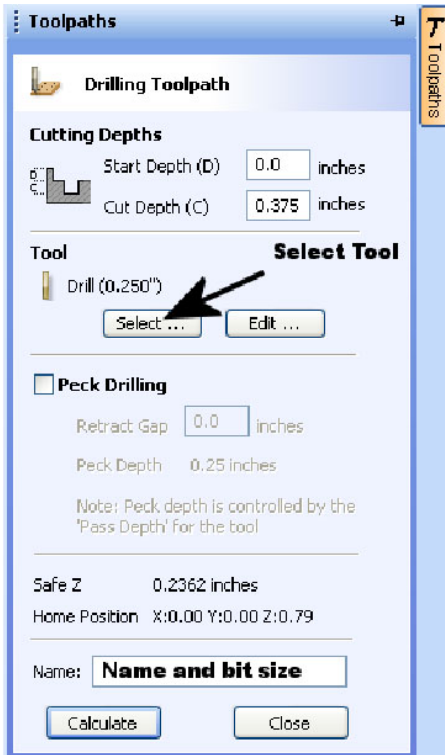

When the toolpath is ready to be created, select the holes to be drilled and open the drilling toolpath tab. Set the cutting parameters of “Start Depth” (top of material to be drilled) and “Cut Depth” (the depth of the hole to be created) then select the tool to be used.

In VCarve Pro the tool database will have PRS air drill templates already defined. The templates are named “PRS Air Drill Position #[1-4] (Define Dia.)”. These templates all have a default diameter of .25 in as the geometry of the tool. The most critical portion of any of these templates is the tool number located at the bottom of the window. This information identifies what drill position the bit is in. The default drills assume you only have one drill and allows you to save up to 9 different tool profiles for the drill. When adding a secondary drill you need to make sure that the tool number matches up with the range of values assigned to that drill.

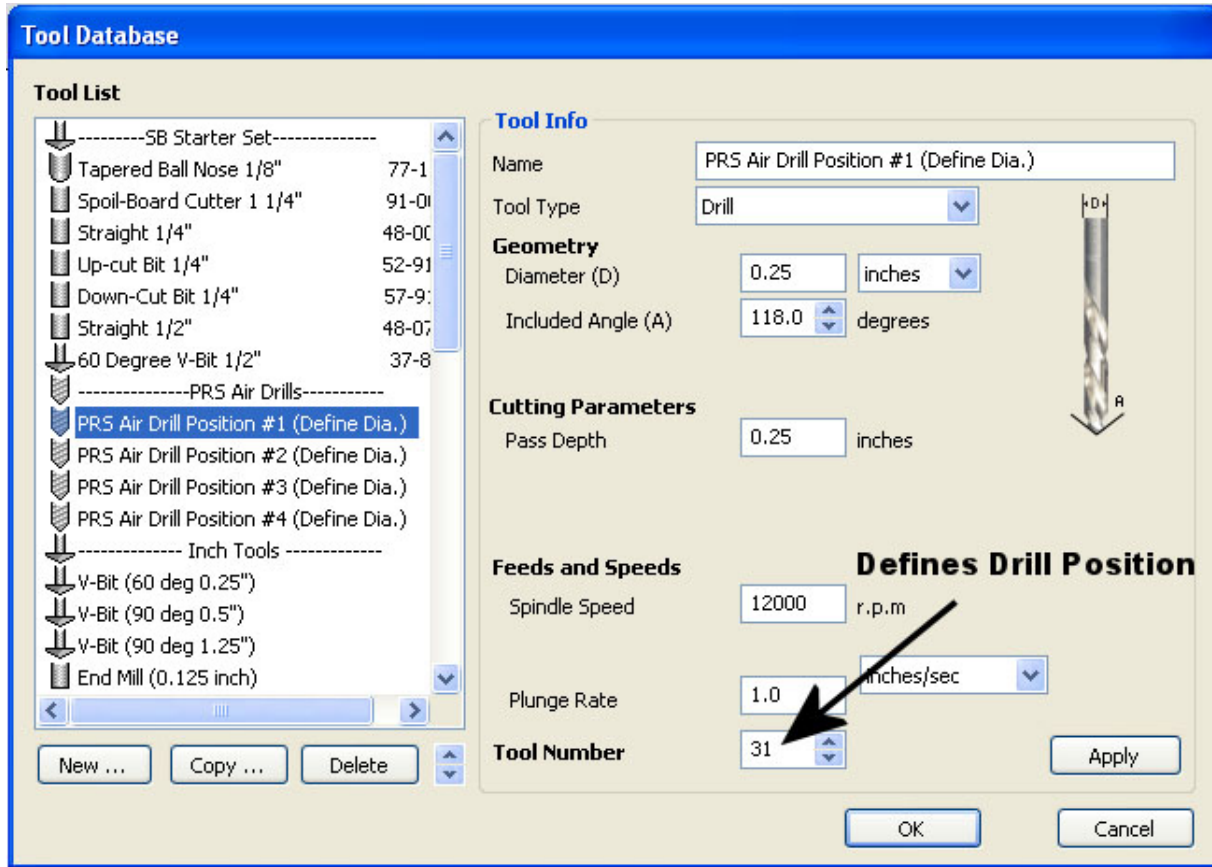

Drill	Tool Number Range
#1	31-39
#2	41-49
#3	51-59
#4	61-69

Note: Most other software packages that have posts for ShopBot will have the ability to define a tool number.

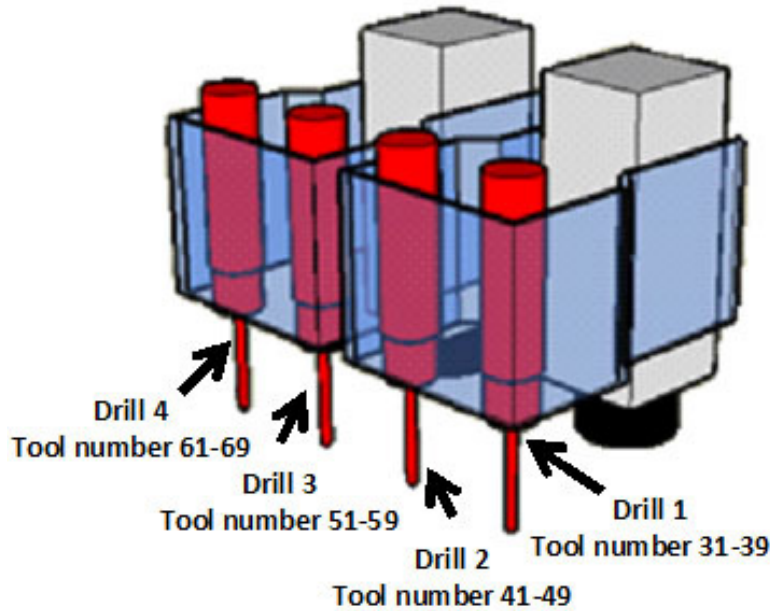

Copy the template of a drill position while that position is highlighted using the copy button at the bottom of the screen. Select the new copy and change the “(Define Dia.)” in the name to the proper size for the tool. Enter in new geometry info, angles, feeds and speeds, and any other info that would be needed then click “Apply” to save the tool.

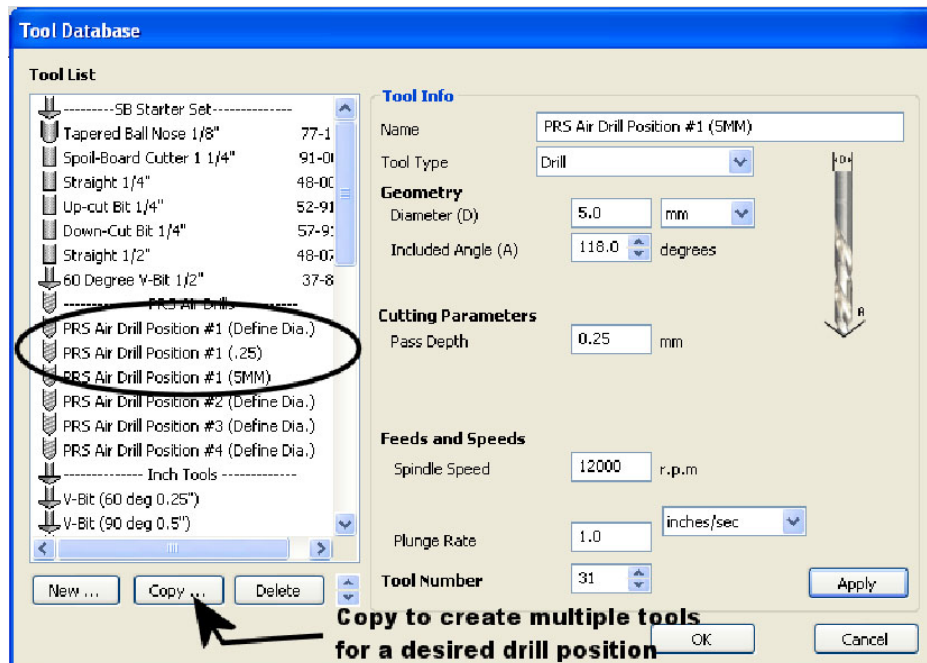

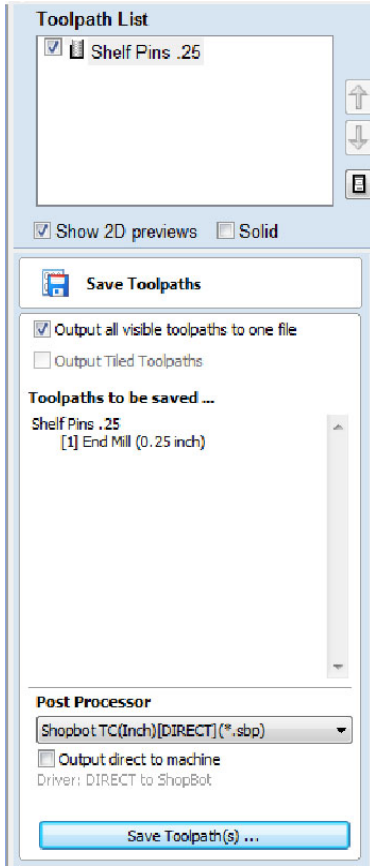

Once a PRS air drill tool has been selected, calculate the tool path. When all toolpaths have been calculated, order them (top to bottom) in the order that they need to cut, then save all toolpaths by outputting the code with either posts: Shopbot TC (Inch)(*.sbp) and Shopbot TC (MM) (*.sbp).

The posts: Shopbot TC (Inch)(*.sbp) and Shopbot TC (MM)(*.sbp), will recognize all spindle and drill positions based on the tool number designated within the design software.

Appendix

Replacing the Spindle Mounting Plate

To replace a spindle mounting plate without the 1/4-20 holes on the edge, remove the spindle and plate by loosening the six socket head mounting screws that hold them to the Z-axis with a 1/4" hex key. Once spindle is removed from the Z-axis, remove the four flat head screws that attach the spindle mounting plate to the spindle. Discard the spindle mount without holes on the 1/2" edge.

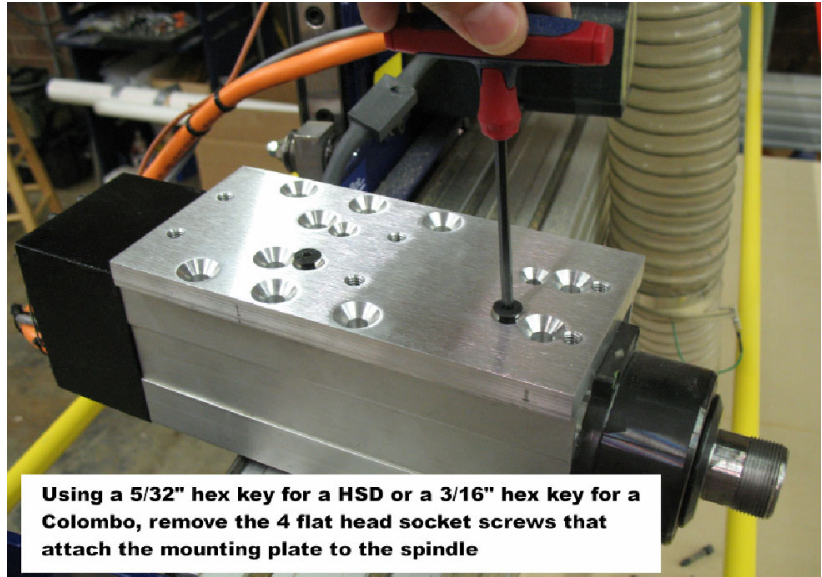

Take the spindle mounting plate with the 1/4-20 holes on the edge (SB# 001620) and attach the plate to the back of the spindle using the flat head screws previously removed. Notice the holes on the 1/2" edge. The hole that is 3/8" from the end should be in the direction of the threads of the spindle. Re-mount the plate and spindle to the Z-axis using the six socket head mounting screws. Re-square the Z-axis head if necessary.

